

**Norstar  
MINUET ACD  
Administration Guide**



*by CINTECH Solutions, Inc.*

**Issue 03  
P0934437**

**V.003.082201**

---

**Copyright © 1997-2001, CINTECH Solutions, Inc.  
MINUET ACD is a trademark of CINTECH Solutions, Inc.  
Norstar and Nortel are trademarks of Northern Telecom.  
Other brand and product names are trademarks or registered trademarks  
of their respective holders.**

---

# Table of Contents

# Table of Contents

---

<b>CHAPTER 1: OVERVIEW .....</b>	<b>7</b>
Introduction.....	8
MINUET ACD Capacities and Features .....	9
MINUET ACD Functions.....	10
Administration Session Overview Flow Chart .....	11
Routing Session Flow Chart .....	12
Administration Maintenance Flow Chart .....	13
Administration Statistics Flow Chart .....	14
Group Status Flow Chart.....	15
<b>CHAPTER 2: INSTALLATION .....</b>	<b>17</b>
Norstar Programming Requirements .....	18
Norstar Voice Port Programming for MINUET ACD Install .....	19
Checking Norstar Feature Code Assignments.....	20
Installing MINUET ACD .....	20
Updating MINUET ACD .....	22
Installing Wallboard Hardware.....	24
<b>CHAPTER 3: ABOUT MINUET ACD .....</b>	<b>25</b>
About MINUET Flow Chart.....	27
Viewing important information .....	27
<b>CHAPTER 4: GROUP ADMINISTRATION .....</b>	<b>34</b>
Group Administration Flow Chart.....	36
Configuring a Group .....	38
<b>CHAPTER 5: AGENT ADMINISTRATION.....</b>	<b>57</b>
Agent Administration Flow Chart .....	58
Configuring an Agent.....	59
<b>CHAPTER 6: LINE ADMINISTRATION .....</b>	<b>72</b>
Line and PRI / DNIS / DID Administration Flow Charts.....	73
Configuring a Line and/or PRI / DNIS / DID .....	74
<b>CHAPTER 7: SYSTEM ADMINISTRATION.....</b>	<b>86</b>
System Administration Flow Chart.....	86
System Configurations .....	87
<b>CHAPTER 8: CHANGE PASSWORDS.....</b>	<b>97</b>
Changing Passwords Flow Chart .....	97
Changing Administration Session Password .....	98
Changing Routing Session Password .....	101
<b>CHAPTER 9: ANNOUNCEMENT MAINTENANCE SESSION.....</b>	<b>104</b>

<b>CHAPTER 10: ROUTING SESSION .....</b>	<b>107</b>
Routing Session Flow Chart .....	108
Enable Day or Night Routing .....	109
<b>CHAPTER 11: ADMINISTRATION MAINTENANCE SESSION .....</b>	<b>112</b>
Administration Maintenance Flow Chart .....	113
Logging .....	114
Changing Administration Session (Cfg) Feature Code .....	118
Changing Routing Session Feature Code .....	119
Changing Administration Statistics Session Feature Code .....	120
Changing Group Status Session Feature Code .....	121
Reset Administration Session Configurations .....	122
Reset Administration Statistics .....	124
Reset All Passwords .....	125
Changing Administration Maintenance Session Password (Feature 9*7) .....	126
<b>CHAPTER 12: ADMINISTRATION STATISTICS SESSION .....</b>	<b>130</b>
Administrative Statistics Flow Chart .....	131
Viewing Administration Statistics .....	132
<b>CHAPTER 13: GROUP STATUS SESSION .....</b>	<b>138</b>
Group Status Flow Chart .....	138
Viewing Group Status .....	139
<b>CHAPTER 14: PERFORMING AGENT FUNCTIONS .....</b>	<b>142</b>
Agent Functions .....	142
Using Analog 2500 Sets .....	150
<b>APPENDICES .....</b>	<b>152</b>
Appendix 1: Error Messages .....	152
Appendix 2: Configuration Worksheets .....	160
Appendix 3: Norstar Non-physical Directory Number .....	165
Appendix 4: MIN / MAX Reference .....	165
<b>INDEX .....</b>	<b>171</b>

# Table of Contents

---

NOTES

# Chapter 1: Overview

# Introduction

## MINUET ACD

MINUET ACD is an Automatic Call Distribution application designed exclusively for use with the Norstar Applications Module and the co-resident Norstar Voice Mail application. MINUET ACD functions and configurations are performed entirely on either the Norstar T7316, M7310, or M7324 Station Sets. There are 5 Feature Sessions that allow you to perform all of the operations and functions for MINUET ACD:

### ▶ Administration Session (Feature 920)

- **About MINUET** - view the Agent Functions Features Codes assigned by Norstar (i.e., Login, Unavailable, Cancel Wrap, Categorize, Calls Queued, and Announcement Maintenance - Administrator Function Feature Code). View the MINUET ACD Feature Session Codes (i.e., Administration, Routing, Administration Statistics, Group Status, and Administration Maintenance). View the ACD Version you are using, the Norstar KSU string, and the Access Version currently in use.
- **Configuration** - configure Agents, Groups, Lines, System Parameters, and change Administration Session and/or Routing Session Passwords.

### ▶ Routing Session (Feature 921)

- **Enable Day or Night Routing** - you will need to manually start and end the Day or Night Routing time period.

### ▶ Administration Statistics Session (Feature 922)

- **Select Date and Time period to view the following statistics:**

- Number of ACD Calls Answered
- Number of ACD Calls Abandoned
- Number of ACD Calls Disconnected
- Average Time To Answer
- Average Time To Abandon
- Number of ACD Calls Per Category Code

### ▶ Group Status Session (Feature 923)

- **For Group 1 and 2, view how many calls are in queue and how long the longest call in queue has been in that Group's queue.**

### ▶ Administration Maintenance Session (Feature 9\*7)

- **Logging**  
As a support tool, you can log call data files, copy these files to floppies, and delete these files
- **Change Administration Session (Configuration) Feature Code (Feature 920)** - if the default 920 Administration Session Feature Code is already in use, a CINTECH Customer Service or Nortel ITAS Technician can help you change this code.
- **Change Routing Feature Code (Feature 921)** - if the default 921 Routing Session Feature Code is already in use, a CINTECH Customer Service or Nortel ITAS Technician can help you change this code.
- **Change Administration Statistics Session Feature Code (Feature 922)** - if the default 922 Administration Statistics Session Feature Code is already in use, a CINTECH Customer Service or Nortel ITAS Technician can help you change this code.
- **Reset Configuration** - you can reset all of the configurations made in the Administration Session for Agents, Groups, Lines, and System Parameters.
- **Reset Statistics** - you can clear the call data statistics collected by the specified dates and time periods.
- **Reset Passwords** - you can reset the Administration Session Password (920), the Routing Session Password (921), and the Administration Maintenance Session Password (9\*7) back to the default (1234) Passwords.
- **Change Administration Maintenance Password** - you can change the Administration Maintenance Password (9\*7).



# MINUET ACD Capacities and Features

MINUET ACD Capacities	Number
Configured Agents	20
Logged In Agents	10
Configured Groups	2
Groups an Agent can log into at one time	2
Configured Lines	15
Routing Tables per Group	2 (Day and Night)
Day Routing Table Steps	6
Night Routing Table Steps	2
VMAIL XFER Steps	4
Installed Voice Ports	2 or 4 (4 maximum)
Simultaneous Announcements	2 or 4
Recorded Announcements	6

Standard Features	Brief Description
Longest Idle	Agent call answering mode - call is distributed to Agent who has been available the longest since last call
Top Down	Agent call answering mode - call is distributed to first available Agent in the order specified
Auto-Logout	Agent is logged out if call is not answered within 15 seconds (or 3 rings)
Calls Queued	Number of calls in queue and time in queue are displayed on Agent's Station Set
Overflow Calls	Specified threshold of calls in queue before overflow occurs and calls are available to Agents in another Group
Call Categorization	Agent Function - allows Agent to enter a Category Code for an ACD Call during wrap time
Cancel Wrap	Agent Function - allows Agent to stop Call Wrap and become available to take a call
Unavailable	Agent Function - allows Agent to go unavailable and not receive ACD Calls
Delay Answer	Routing Command - the specified time you want to delay the answering of a call by the ACD Group
Forced Announcement	Routing Command - plays a recorded announcement without interruption
Announcement	Routing Command - plays a recorded announcement that is interrupted when Agent becomes available

Standard Features - continued

Distribute	Routing Command - looks for first available Agent in
------------	--

	Group to send call during specified time interval
Wait Announcement	Routing Command - plays the second recorded announcement to remind caller to wait for call to be answered
Go To Step	Routing Command - returns caller to a previous step and then repeats subsequent commands
Transfer To (XFR TO DN)	Routing Command - transfers call to specified Norstar DN
Voice Mail Transfer (VMail XFR)	Routing Command - transfer call to a specified Norstar Voice Mail mailbox
Group	Routing Command - sends call to a different Group
No Answer	Night Routing Command - call is not answered by ACD
Disconnect	Night Routing Command - ends the call
Wallboard Support	Display ACD Call statistics across a Wallboard
2500 Analog Set Support	Agents can use the 2500 Set to take calls; however, limited to Login/Logout and Available/Unavailable functions
ICLID	Caller Identification support
French/Spanish Language Station Set Support	Station Set display
Target Lines and DNIS/DID Numbers	Target Lines and DNIS are supported in Line Administration
E1 Trunk Support	European Trunk Support (CALA & Australia)

## MINUET ACD Functions

MINUET ACD performs 5 basic operations for every incoming ACD call:

- ▶ **Directs Call to a Group**
- ▶ **Checks Routing Table**
- ▶ **Executes Routing Commands**
- ▶ **Checks Overflow Call Threshold**
- ▶ **Distributes Call to Agent**

In Chapters 2 and 3, Group Administration and Agent Administration, configuration directions are provided so you can distribute an ACD Call to the Group and Agent(s) you specify.

### Directs Call to a Group

Incoming Norstar telephone lines can be assigned to 2 ACD Groups. For example, Norstar lines 001, 002, 003, and 004 can be assigned to Group 1 and lines 005, 006, 007, and 008 can be assigned to Group 2.

When an ACD call comes in on a line, MINUET ACD checks the Line Configuration Table and directs the call to the Group assigned to the line. MINUET ACD then checks the Routing Table. If that Line is not assigned, ACD then ignores the call.

### Checks Routing Table

You can toggle Day Routing or Night Routing.

MINUET ACD checks the Day Routing or Night Routing table to determine how the call should be handled.

### Executes Routing Commands

Day and Night Routing Command Tables direct the call through sequential commands. Commands include:

- ▶ DELAY ANSWER (Day)

- ▶ ANNOUNCEMENT OR FORCED ANNOUNCEMENT (Day)
- ▶ WAIT ANNOUNCEMENT (Day)
- ▶ DISTRIBUTE (Day - can be used twice for Steps 3 and/or 5)
- ▶ GO TO STEP, VMAIL XFR, XFR TO, or GROUP (Day)
- ▶ NO ANSWER (Night)
- ▶ NITE ANNOUNCEMENT (Forced)
- ▶ VMAIL XFR (Night)
- ▶ DISCONNECT (Night)

The following sample Group 1 Day Routing Command Table delays the answering of the call for 10 seconds, plays announcement #1, distributes the call for 35 seconds, plays wait announcement #2, distributes the call for 20 seconds returns to step 3, and repeats steps 3 through 6 until call is answered.

STEP	Day Command	Value
01	DELAY ANSWER	00:10
02	ANNOUNCEMENT	1
03	DISTRIBUTE	00:35
04	WAIT ANNOUNCEMENT	2
05	DISTRIBUTE	00:20
06	GO TO STEP	3

The following sample Group 1 Night Command Routing Table forces Nite Announcement #3 to inform the caller that business hours are over, and then disconnects the call.

STEP	Night Command	Value
01	NITE ANNC.	3
02	DISCONNECT	

### Checks Group Overflow Table

As MINUET ACD executes routing commands, it also tracks how many calls are waiting in the Group queue. You can specify an overflow threshold of calls so that when too many calls are waiting in one Group, they can answered by Agents of a different Group.

### Distributes Call to Agent

MINUET ACD monitors the activity of each Agent in each Group. When a call comes in, it is directed by a routing command to an Agent. If only one Agent is available, MINUET ACD sends the call to that Agent; however, if more than one Agent is available, MINUET ACD refers to the Group's Agent Selection method.

There are 2 Agent Selection methods from which to choose:

- ▶ LONGEST IDLE - selects Agent who has been available for the longest time since last handling a call.
- ▶ TOP DOWN - selects available Agent starting at top of the assigned Group position list.

## Administration Session Overview Flow Chart

This flow chart provides an overview of the Administration Session's station set interface. At the start of each chapter (i.e., About MINUET, Group Admin, Agent Admin, Line Admin, System Admin, and Change Password), a detailed flow chart is displayed.

# Overview

---

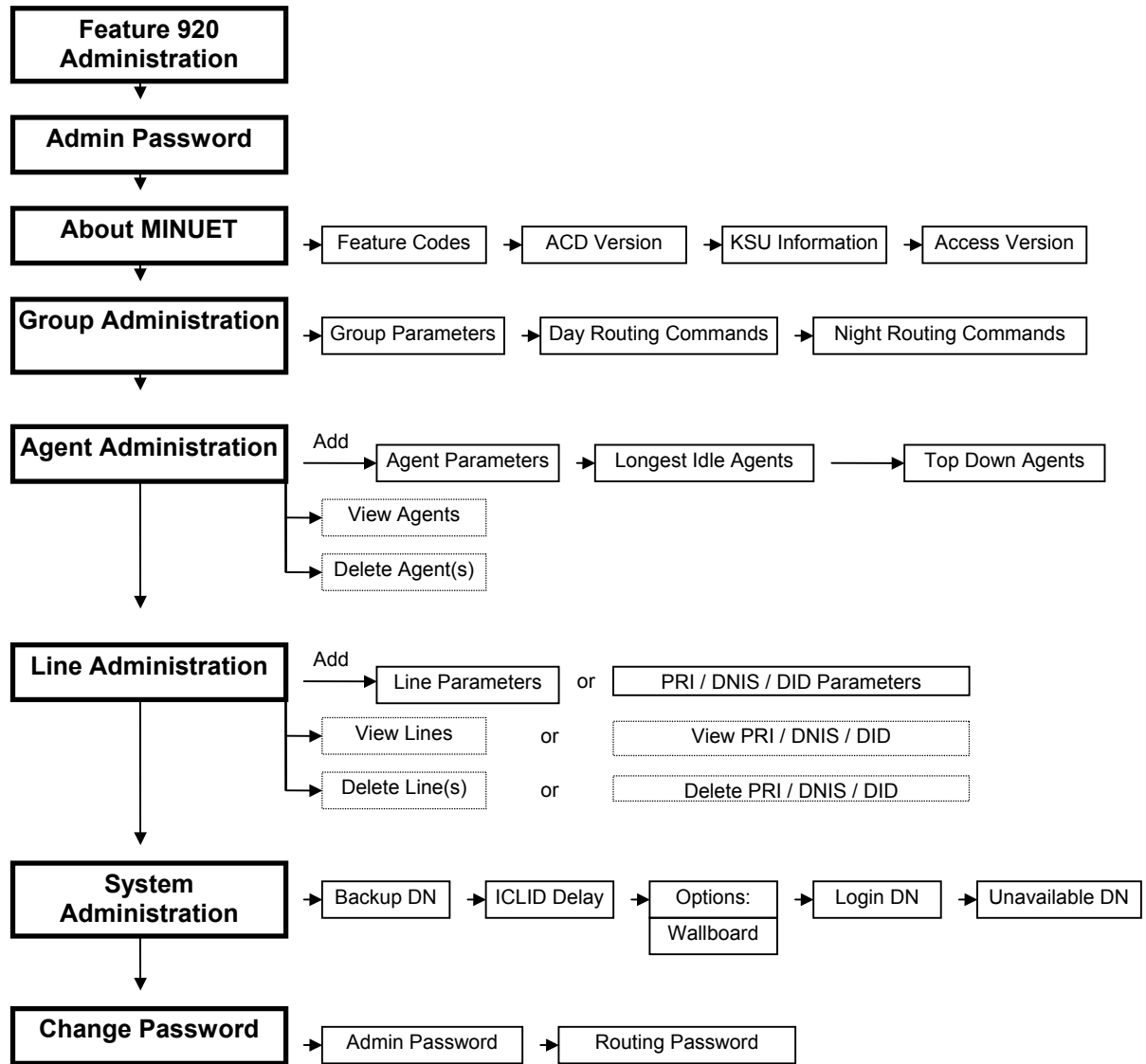

## Routing Session Flow Chart

This flow chart provides the details of the Routing Session's station set interface.

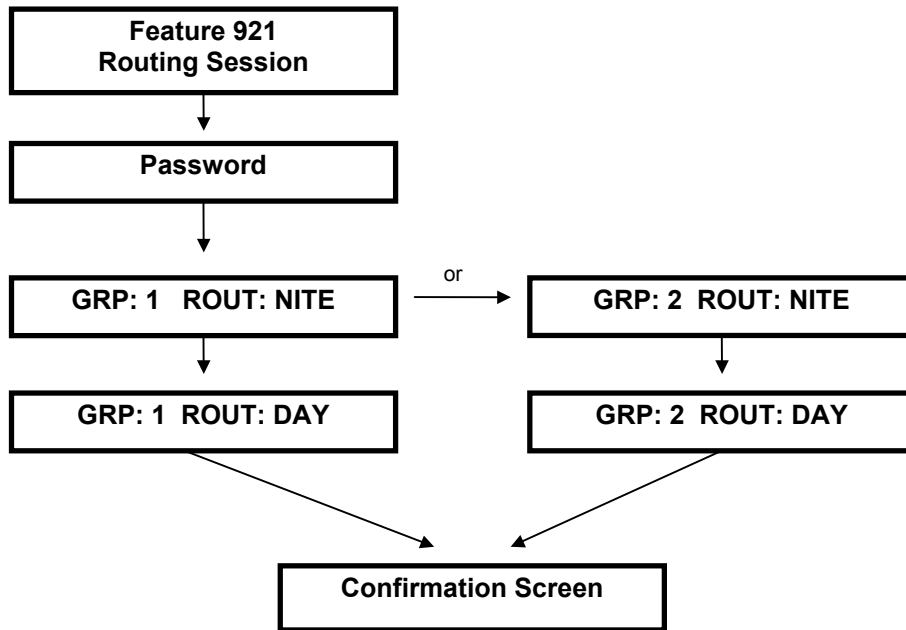

## Administration Maintenance Flow Chart

This flow chart provides the details of the Administration Maintenance Session's station set interface.

**Overview**

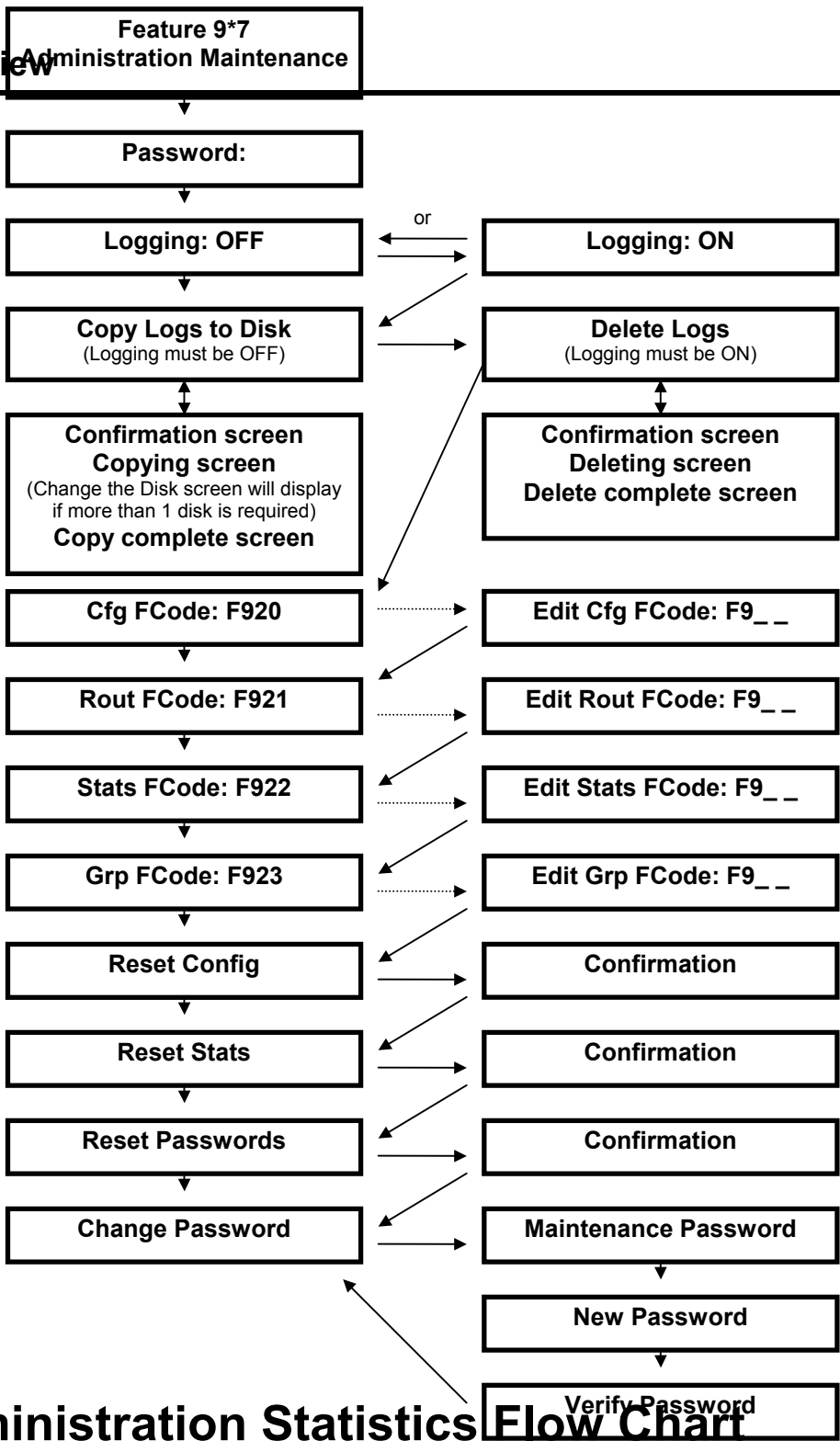

**Administration Statistics Flow Chart**

This flow chart provides the details of the Administration Statistics Session's station set interface.

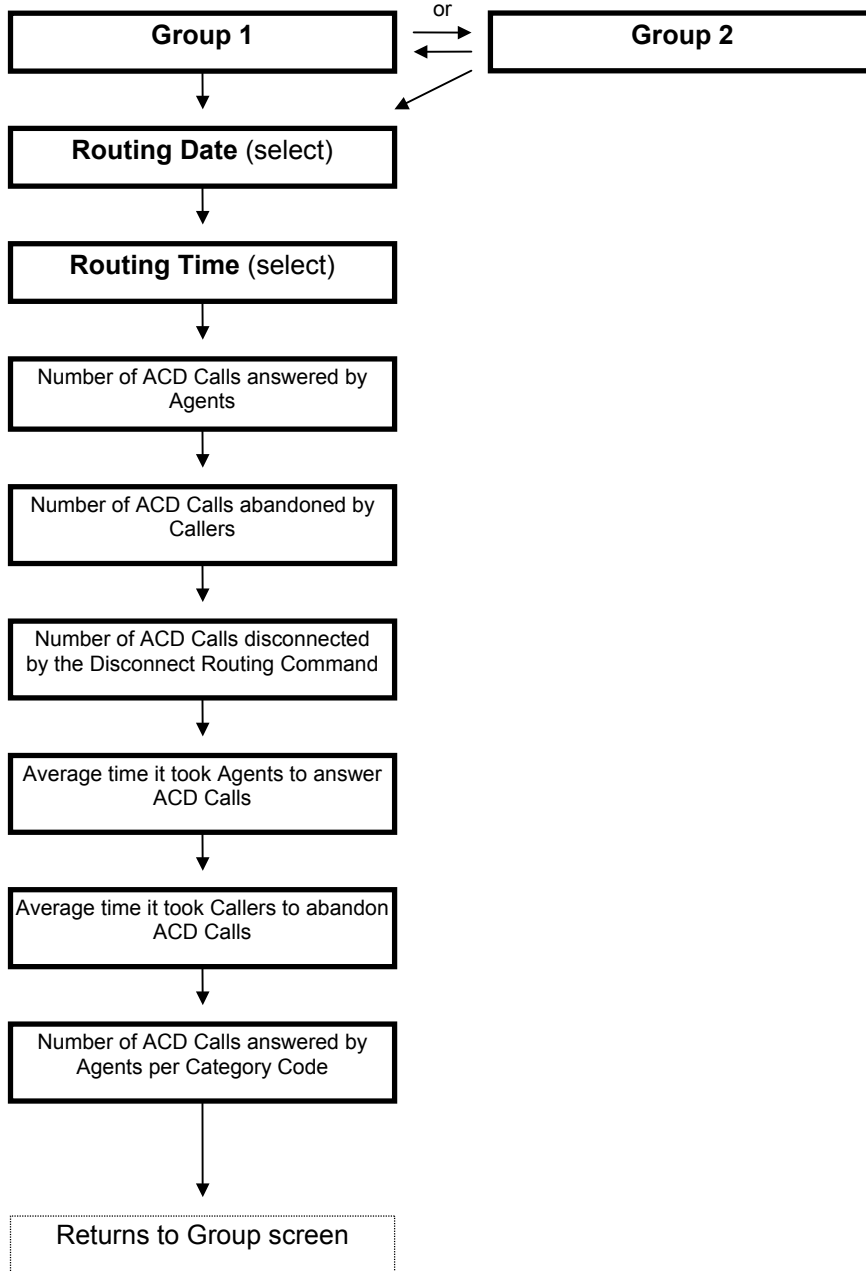

## Group Status Flow Chart

This flow chart provides the details of the Group Status Session's station set interface.

**Feature 923  
Group Status**

**Overview**

---

**Group 1 (view only)  
Calls Queued  
Time In Queue**

5 seconds

**Group 2 (view only)  
Calls Queued  
Time In Queue**

Session times out after 5  
seconds and returns to  
Date and Time screen



# Chapter 2: Installation

# Norstar Programming Requirements

When you are ready to program the Norstar KSU, make sure the following ACD requirements are met:

### ACD and Non-ACD C.O. Lines

- ▶ Determine the Lines used for ACD
- ▶ ACD Lines must be assigned to ACD and the Backup Station Set only.

### ACD Line Settings (Norstar Trk/Line Data feature):

- ▶ Assign to Backup Station Set DN only.
- ▶ Set Prime Set to NONE (Prime Set:None)
- ▶ Set Trunk Mode to Supervised (Trunk Mode:Super)
- ▶ Set ACD Line Type to Pool or Public (Line Type:Pool or Public)

*Note: If Line Type is set to Pool, the Line can be used for Outgoing Calls.*

### Agent Station Set and Voice Port DN Specifications:

- ▶ Each Station Set must have at least 2 Intercom buttons. ACD Lines ring on the Intercom button because Lines are not assigned to the DN.
- ▶ There can be no line or ringing appearance of ACD configured Lines on any Agent Set or enhanced CAP unit.
- ▶ Agents cannot log into enhanced CAP unit
- ▶ Prime = I/C (or NONE for CENTREX Norstar; the DN is programmed in "Beyond CTX" to Norstar only).
- ▶ FULL HF, AUTO HF, HF ANSWERBACK = YES

### Backup DN Specifications

- ▶ Assign ACD Lines to the dedicated Backup Station Set only.
- ▶ Record the Extension Number for the Set so that during Norstar Programming you can assign to it all ACD Lines.
- ▶ ACD Lines should have a ringing appearance on this Set and should not be assigned anywhere else.

### General Specifications

- ▶ DRT, TRANSFER CALLBACK, and FORWARD NO ANSWER/BUSY ON Agent station sets must be 4 rings or higher.
- ▶ DISCONNECT SUPERVISION (DS) should be enabled on all ACD Lines, KSU, DR cartridge, and Trunk Module.

# Norstar Voice Port Programming for MINUET ACD Install

Prior to installing MINUET ACD, follow these steps to set the minimum and maximum value for Voice Ports:

- 1 On the **T7316**, **M7310**, or **M7324 Station Set**, press the **Feature** button. On the keypad, type in **915** for the feature code.

**MIN /MAX Note:** Refer to **Appendix 4: MIN/MAX Reference** for detailed information and examples of how to properly configure these values for Voice Ports.

**Note:** If Feature 915 is being used by another application, refer to **Running XFTEST** section to view the feature code assigned for the Administration Program.

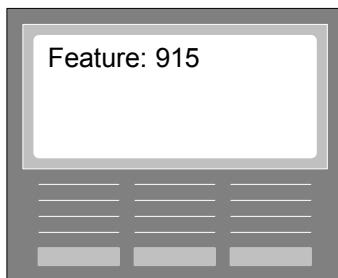

The Administration Program Password screen will display.



- 2 Type in the **Password** for your Application Module's **Administration Program Password**. The next screen to display is the **Access/2 Server**.
- 3 Press the **Admin** softkey. The next screen to display is the Admin Directory screen starting with **A..**
- 4 Press the **NEXT** softkey to scroll through the applications until you display: **C. Voice & Fax**.
- 5 Press the **SHOW** softkey. The Choice of appl screen will display.
- 6 Press the **SHOW** softkey. The ACCESS Server screen will display.
- 7 Press the **NEXT** softkey. The NrstrVM screen will display.
- 8 Press the **SHOW** softkey. The a. Voice Port screen will display.
- 9 Press the **SHOW** softkey. The Voice Ports screen will display.
- 10 Make sure **MIN** is set to 2 and **MAX** is set to 2 (MIN=2 MAX=2).
- 11 Press the **Rls** key to exit this session.

**Note:** After completing the MINUET software installation, the Norstar Voice Mail Voice Ports MIN and MAX values can be reset. **When resetting, it is critical that the total number of the MIN and MAX values is at least 1 less than the total number of ports installed on the Applications Module.**

# Checking Norstar Feature Code Assignments

Before installing MINUET ACD, the current feature code assignments in the Norstar must be checked to ensure that MINUET ACD's key Feature Code assignments are available for use. Do not start the MINUET ACD installation until the Feature Codes 920, 921, 922, and 923 **are not** assigned (in an Active or Inactive state). Refer to Running XFTEST below to make sure these codes are not assigned. If you experience any difficulty in running XFTEST, contact a CİNTECH Customer Service Technician or a Nortel ITAS Technician immediately.

## Running XFTEST

Follow these steps to run XFTEST:

- 1 On the **T7316**, **M7310**, or **M7324 Station Set**, press the **Feature** button. On the keypad, type in **\*\*XFTEST (\*\*938378)**.
- 2 Type in the **Norstar Config Password**.
- 3 Press the **FIRST** softkey to view the first Feature Code registered with Norstar.
- 4 Press the **TEST** softkey to see if this Feature Code is in use. After a few seconds, an "Active" or "Inactive" message will display.
- 5 If the Feature Code is "Active", press the **OK** softkey. You will be returned to the "Test" prompt.
- 6 Press the **NEXT** softkey to display all the Active and Inactive Feature Codes. Feature Codes 920, 921, 922, and 923 should not display as Active or Inactive. They should be available for use. If any of these 4 Feature Codes do display as Active or Inactive, they must be deleted (or cleared) by pressing the **DELETE** softkey. Make sure when deleting, that the application (other than a MINUET ACD session) using the Feature Code can be programmed to a different Feature Code.
- 7 When you are completed and Feature Codes 920, 921, 922, and 923 are cleared and available for MINUET ACD, press the **Rls** key.

# Installing MINUET ACD

It is assumed that the Norstar Applications Module has already been connected to the Norstar KSU, Station Sets have been connected, and the Voice Mail Application has been installed.

**Note:** You can call CİNTECH (1-800-944-3901) prior to the installation to receive your Verification Key. If you do, have ready your Applications Module's serial number, company name, address, and contact. This 10 digit Serial Number is found under the Admin UI Feature Session, Access/2 Server, Admin, I.Serial Number.

This MINUET installation is performed entirely from the **M7310**, **T7316**, **C3050**, **C3060**, or **M7324 Station Set**. Follow these steps:

- 1 The Norstar Applications Module can be in **Presentation Manager** or **Non-Presentation Manager** mode.
- 2 Open up the Application Module's cover and insert the **Install Disk** in the disk drive.
- 3 On the **T7316**, **M7310**, or **M7324 Station Set**, press the **Feature** button. On the keypad, type in **915** for the feature code.

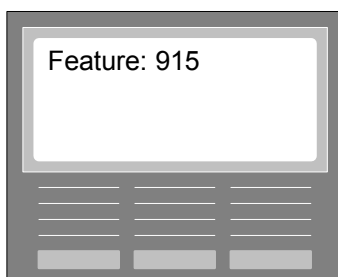

The Administration Program Password screen will display.

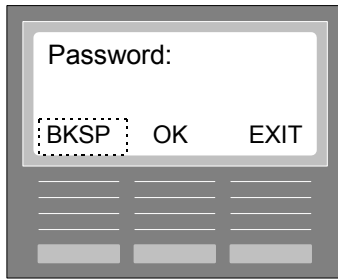

- 4 Type in the **Password** for your Application Module's **Administration Program Password**. Press the **OK** softkey. The next screen to display is the **Access/2 Server**.
- 5 Press the **Admin** softkey. The next screen to display is the Admin Directory screen starting with **A..**
- 6 Press the **NEXT** softkey to scroll through the applications until you display: **H. Appl Install**.
- 7 Press the **SHOW** softkey. The next screen to display reminds you to **Insert Floppy** (that you completed in Step 2). Press the **INSTL** softkey. The following messages will display briefly:

#### **One moment pls**

The Date and Time screen will briefly display.

#### **ACD Installing**

- 8 The **Install key:** screen will display. If you haven't previously called, call CİNTECH (1-800-944-3901) to request your Install Verification Key. Then type this **key** into the field. When completed, press the **OK** softkey. The next messages to display:

#### **Copying ACD - % Complete**

#### **Copying Startup**

The message will display to insert the remaining install/update disk(s) (if any).

The **Install complete** message will briefly display and an attention tone will sound from the Station Set when MINUET is installed. If the installation cannot be completed, an **Install Failed** message will display and an error tone will sound from the Stations Set. Call CİNTECH Customer Service if you receive the Install Failed message.

The Date and Time screen will display.

#### **Backup Station Set DN (required)**

- 9 When the Install is complete, remove the Install disk and close the cover. At this time, you will need to specify a Backup Station Set DN. Follow the directions provided in System Parameters chapter to specify the Backup Station Set DN.

#### **Graceful Reboot**

When the Install is complete and the Backup station Set has been specified, you must perform a Graceful Reboot. Make sure there is not a floppy disk in the disk drive.

Follow these steps:

- 1 On the **T7316, M7310, or M7324 Station Set**, press the **Feature** button. On the keypad, type in **915** for the feature code.



## Installation

---

The Administration Program Password screen will display.

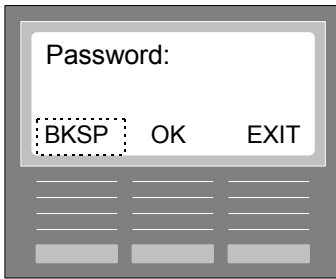

- 2 Type in the **Password** for your Application Module's **Administration Program Password**. The next screen to display is the **Access/2 Server**.
- 3 Press the **NEXT** softkey. The **System shutdown** screen will display.
- 4 Press the **NEXT** softkey. The **System reboot** screen will display.
- 5 Press the **SHOW** softkey. The **Reboot type** screen will display.
- 6 Press the **GRACE** softkey (for graceful). The **Reboot Graceful?** Screen will display.
- 7 Press the **YES** softkey. The **Rebooting . . .** message will display. The Reboot may take several minutes. The Reboot type screen will then briefly display before you are returned to the Date and Time screen.

***Note:** Any time MINUET ACD is restarted, it will start up in Night Routing regardless of the time of day. Refer to Chapter 10, Routing Session, to enable Routing.*

## Updating MINUET ACD

Before performing an Update, note the following:

- ▶ All Agents must be logged out.
- ▶ MINUET will not answer incoming calls during the Update process; however, Voice Mail will not be affected.
- ▶ Step 8 below requires you to enter a Verification Key. You can call CINTECH (1-800-944-3901) and obtain this Verification Key before performing the Update. When you call, have ready your Applications Module's serial number, your company name, address, and contact.

This MINUET update is performed entirely from the **T7316, M7310, or M7324 Station Set**. Follow these steps:

- 1 The Norstar Applications Module can be in **Presentation Manager** or **Non-Presentation Manager** mode.
- 2 Open up the Application Module's cover and insert the **Update Disk** in the disk drive.
- 3 On the **T7316, M7310, or M7324 Station Set**, press the **Feature** button. On the keypad, type in **915** for the feature code.

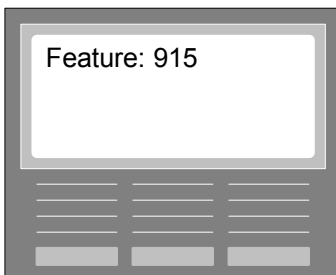

The Administration Program Password screen will display.



- 4 Type in the **Password** for your Application Module's **Administration Program Password**. The next screen to display is the **Access/2 Server**.
- 5 Press the **Admin** softkey. The next screen to display is the Admin Directory screen starting with **A..**
- 6 Press the **NEXT** softkey to scroll through the applications until you display: **H. Appl Install**.
- 7 Press the **SHOW** softkey. The next screen to display reminds you to **Insert Floppy** (that you completed in Step 2). Press the **INSTL** softkey. The following messages will display briefly:

**One moment pls**

The Date and Time screen will briefly display.

**ACD Updating**

- 8 The **Update key:** screen will now display. If you haven't called previously, call CİNTECH (1-800-944-3901) to request your Update Verification Key. Then type this **key** into the field. When completed, press the **OK** softkey. The next messages to display:

**Copying ACD - % Complete**

**Copying Startup**

The message will display to insert the remaining Update disk(s) (if any).

The **Update complete** message will briefly display and an attention tone will sound from the Station Set when MINUET is updated. If the update cannot be completed, an **Update Failed** message will display and an error tone will sound from the Stations Set. Call CİNTECH Customer Service if you receive the Update Failed message.

The Date and Time screen will display. MINUET ACD will then be operational.

## Installing Wallboard Hardware

The following diagram provides a basic view of the Wallboard's installed components.

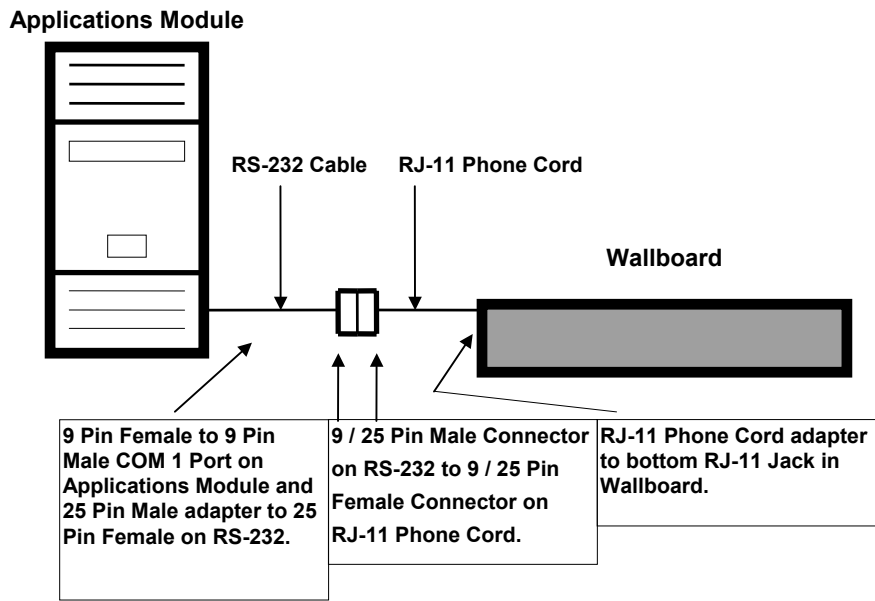

Follow these steps to install the Wallboard hardware components:

**1** Connect the **RS-232 Cable** to the **Applications Module**.

- Connect **RS-232 9 Pin** female adapter to **9 Pin** male adapter on **COM1 Port** of the **Applications Module**.

*Note: An older Applications Module II may require a COM3 Port connection. If you have difficulty in determining the Applications Module you are using, please contact your Northern Telecom Distributor.*

- Connect the other end of the **RS-232 Cable** (male 9 or 25 Pin adapter) to the **RJ-11 Phone Cord** (female 9 or 25 Pin adapter).

*Note: It is not required but you can use an RS-232 Cable Check Tester between the RS-232 Cable and RJ-11 Phone Cord connectors to ensure that the RS-232 operates correctly. The Tester is a female/male 25 Pin adapter.*

- Connect the other end of the **RJ-11 Phone Cord** (jack adapter) to the **bottom Wallboard Jack**.

**2** Plug in the **Wallboard's Power Cord** into an outlet. The Wallboard powers on and off by plugging in or removing the power cord.

*Note: You can also use a T-Connector to connect the RS-232 Cable and the RJ-11 Phone Cord. Use the connection on the left side as you are facing the T-Connector from the Wallboard.*



# **Chapter 3: About Minuet ACD**

## About MINUET ACD

---

In this Chapter you can view the following important information:

- ▶ **Agent Functions Feature Codes assigned by Norstar**
  - Login
  - Unavailable
  - Cancel Wrap
  - Call Category (Categorize)
  - Calls Queued
- ▶ **Administrator Function Code assigned by Norstar**
  - Announcement Maintenance
- ▶ **MINUET ACD Feature Session Codes**
  - Administration Session
  - Routing Session
  - Administration Statistics Session
  - Group Status Session
  - Administration Maintenance Session
- ▶ **MINUET ACD Version currently in use**
- ▶ **Norstar KSU string identifying the KSU currently in use**
- ▶ **Access Version**

## About MINUET Flow Chart

This flow chart provides the menu structure for About MINUET.

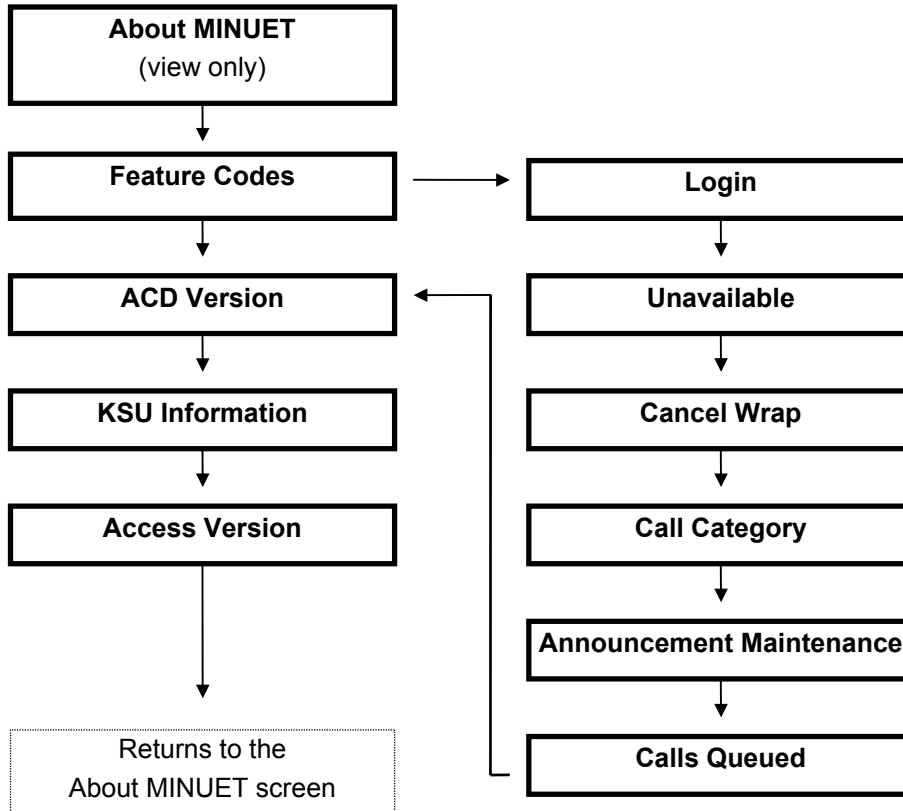

## Viewing important information

### Agent and Administrator Function Feature Codes

Using either a **T7316**, **M7310**, or **M7324 Station Set** follow these directions to view the Agent Functions Feature Codes:

- 1 On the Station Set, press the **Feature** button and then press **920** on the dial pad for the Administration Session Feature Code.



The Administration Session Password screen will display.

## About MINUET ACD

---



- 2 The **default Password** is **1234**. Refer to the Changing Password Chapter if you want to change to a different Password. On this Password screen, type in the current **Password**. When you start typing, the BKSP (backspace) softkey will display so you can delete characters from right to left.
- 3 When completed, press the **OK** softkey. If the correct Password has been entered, the About MINUET screen will display.



- 4 Press the **SHOW** softkey. The Features Codes screen will display.

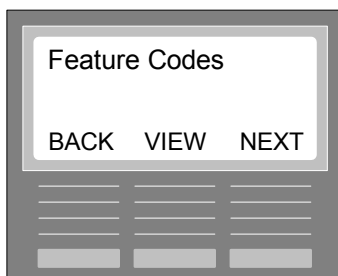

- 5 Press the **VIEW** softkey. The Login Feature Code will display.



(Agent Function)

- 6 Press the **NEXT** softkey. The Unavailable Feature Code will display.

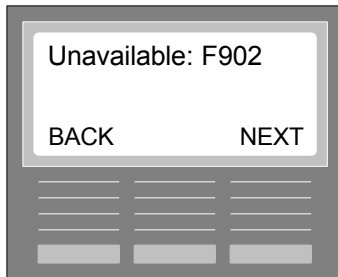

(Agent Function)

- 7 Press the **NEXT** softkey. The Cancel Wrap Feature Code will display.



(Agent Function)

- 8 Press the **NEXT** softkey. The Call Category Feature Code will display.

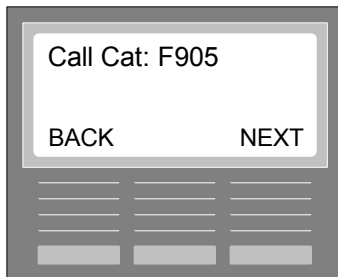

(Agent Function)

- 9 Press the **NEXT** softkey. The Announcement Maintenance Feature Code will display.

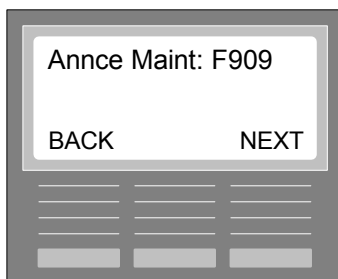

(Administration Function)

- 10 Press the **NEXT** softkey. The Calls Queued Feature Code will display.

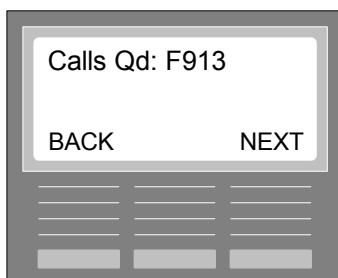

(Agent Function)

- 11 All Agent and Administration Function Feature Code screens have displayed. Pressing the **BACK** softkey will return you to the Feature Codes screen. Pressing the **NEXT** softkey will display the Administration Session Feature Code screen.

*Note: Refer to the Norstar Station Set manual to program these Agent Functions on the programmable memory keys on your Station Set. Refer to the Performing Agent Functions chapter in this guide for directions to perform the Agent Functions. Refer to the Announcement Maintenance Session chapter for directions to perform this Administration Function.*

### MINUET ACD Feature Session Codes

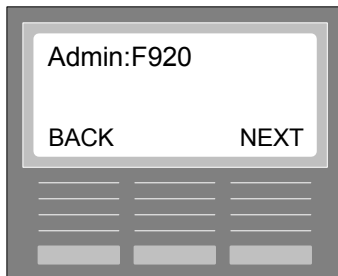

- 12** Press the **NEXT** softkey to display the Routing Session Feature Code screen.

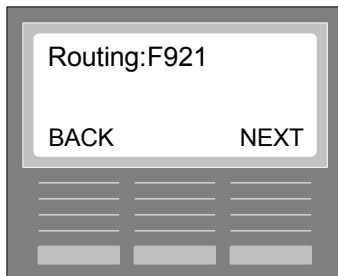

- 13** Press the **NEXT** softkey to display the Administration Statistics Session Feature Code screen.

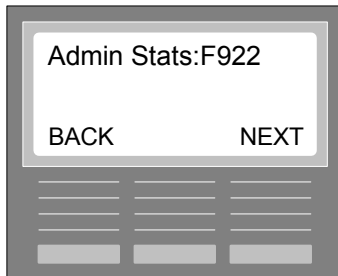

- 14** Press the **NEXT** softkey to display the Group Status Session Feature Code screen.

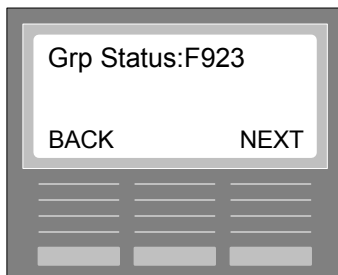

- 15** Press the **NEXT** softkey to display the Administration Maintenance Session Feature Code screen.

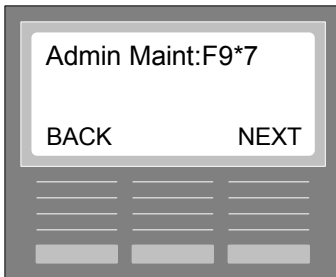

## ACD Version

- 16 Press the **NEXT** softkey to display the ACD Version screen.

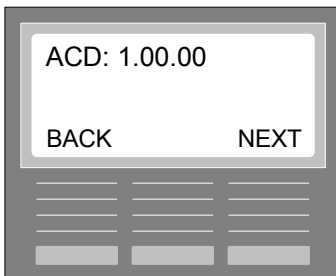

**Note:** This screen displays the current Version of MINUET ACD in use. The Version number is very important to CINTECH Customer Service if you are calling for application support.

Pressing the **BACK** softkey will return you to the Feature Codes screen. Pressing the **NEXT** softkey will display the KSU string screen.

## KSU

- 17 Press the **NEXT** softkey to display the **KSU** screen.

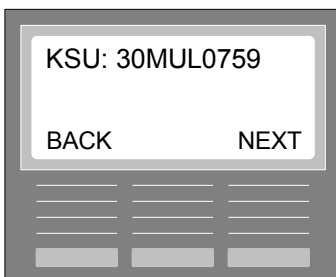

(Example)

**Notes:** This screen displays the current Norstar KSU in use. This string information is very important to CINTECH Customer Service if you are calling for application support.

MINUET ACD must be running and the Backup Station Set DN configured before the correct KSU string displays.

Pressing the **BACK** softkey will return you to the ACD Version screen. Pressing the **NEXT** softkey will display the About MINUET screen.

## Access Version

- 18 Press the **NEXT** softkey to display the **Access Version** screen.



Press the **SHOW** softkey to display the Version Number.



This number will display for 3 seconds and then the Access Ver # screen will re-display.

**Note:** MINUET ACD must be running and the Backup Station Set DN configured before the correct Access Version displays.

Pressing the **BACK** softkey will return you to the KSU screen. Pressing the **NEXT** softkey will display the About MINUET screen.







# Chapter 4: Group Administration

In this Chapter you can perform the following **Group Administration** configurations for **1 or 2 Groups**:

- ▶ **Select Group (1 or 2)**
- ▶ **Change the Name of the Group**
- ▶ **Specify Transfer (XFR) DN**
- ▶ **Specify Wrap Duration**
- ▶ **Specify Longest Idle or Top Down Agent Selection**
- ▶ **Enable/Disable Prompted Categorization**
- ▶ **Specify Overflow Calls Threshold**
- ▶ **Specify Day Routing Commands**
- ▶ **Specify Night Routing Commands**
- ▶ **Update Configuration**

# Group Administration Flow Chart

This flow chart provides the menu structure for Group Administration.

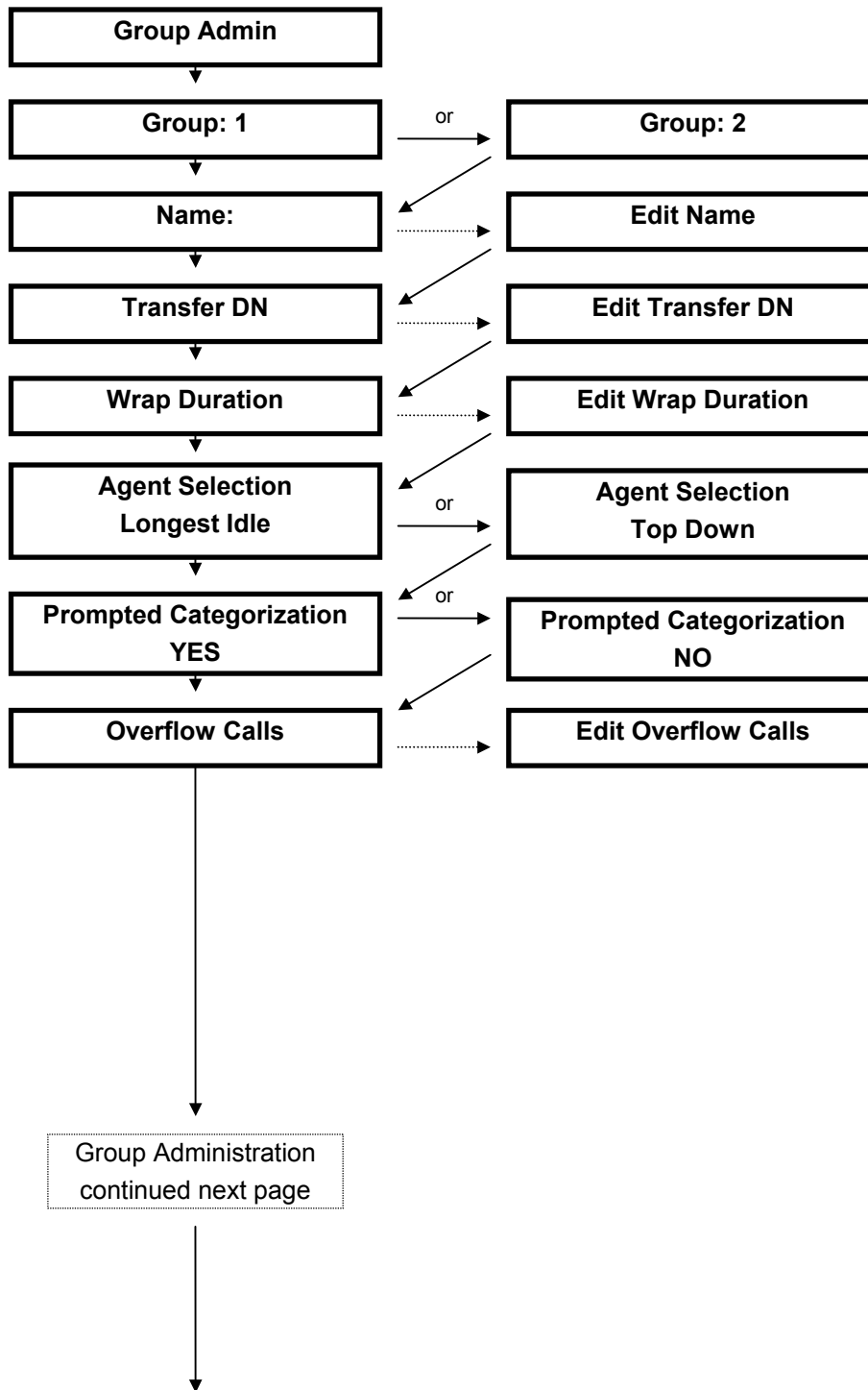

Group Administration Flow Chart – continued

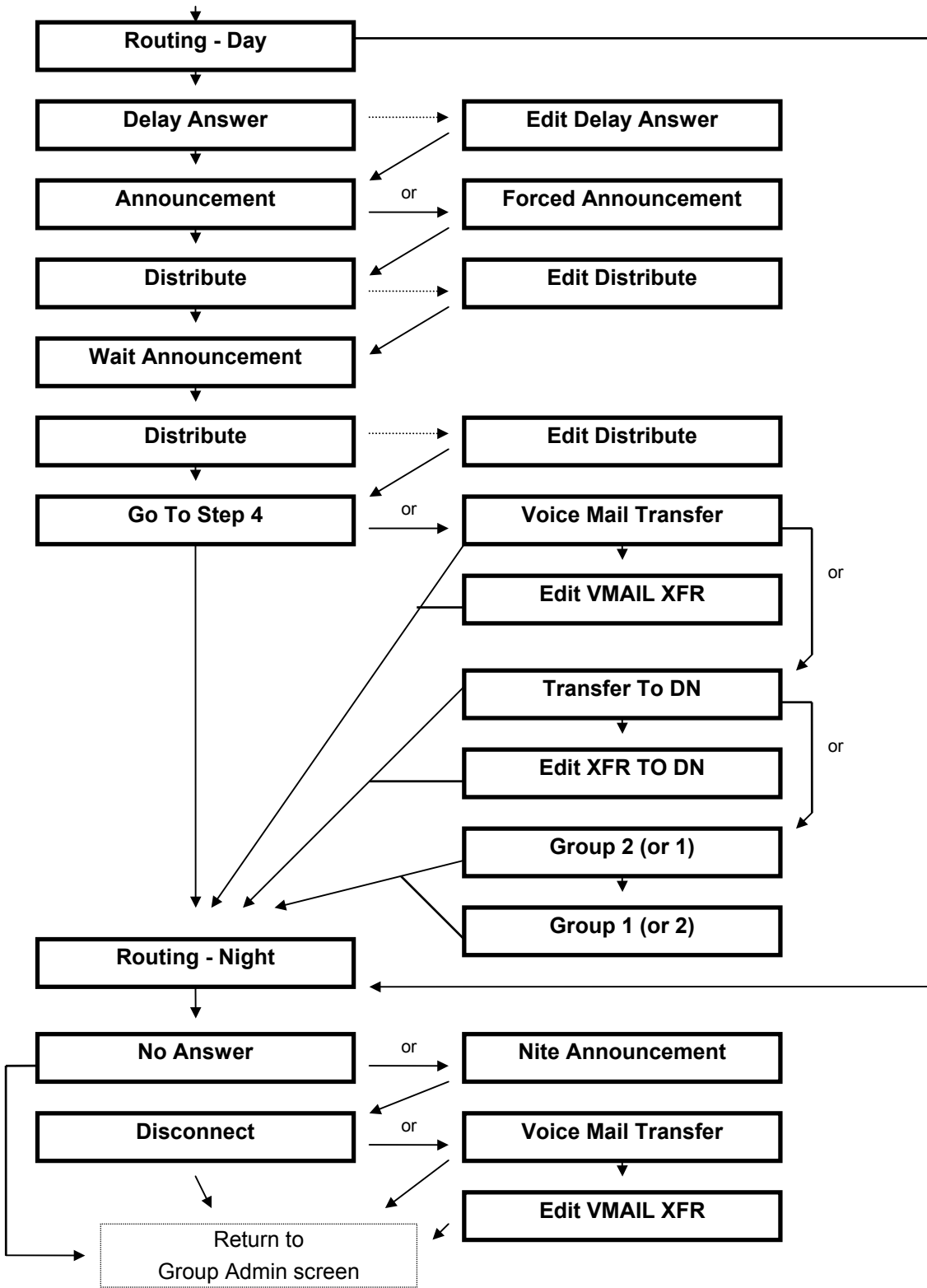

# Configuring a Group

Using either a **T7316**, **M7310**, or **M7324 Station Set** follow these directions to configure a Group:

- 1 On the Station Set, press the **Feature** button and then press **920** on the dial pad for the MINUET ACD Feature Code.



The Administration Password screen will display.



- 2 The **default Password** is **1234**. Refer to the Changing Password Chapter to provide a different Password. On this Password screen, type in the current **Password**. When you start typing, the BKSP (backspace) softkey will display so you can delete characters from right to left.
- 3 When completed, press the **OK** softkey. The About MINUET screen will display.



- 4 Press the **NEXT** softkey. The Group Administration screen will display.



- 5 Press the **SHOW** softkey. The Group selection screen will display.

**Note:** Pressing the **#** or the **\* key** from any screen in Group Admin, will return you to the Group Admin screen.

## Select a Group

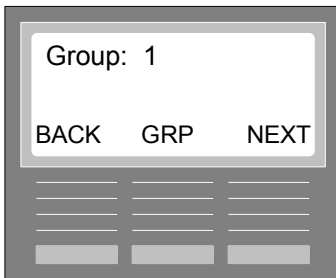

- 6 To configure **Group 1**, press the **NEXT** softkey. The Name screen will display. The GRP softkey toggles between Group 1 and Group 2. The BACK softkey returns you to the Group Admin screen.



## Change the Name of the Group

- 7 To change the name of **Group 1**, press the **EDIT** softkey. The next screen to display:

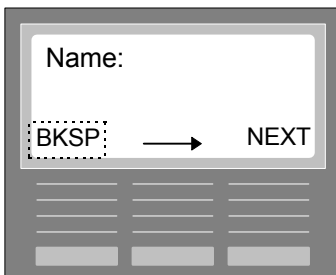

- 8 Type in the **Name of the Group** using the dial pad. For example: if you want to type in the name "Service", you would press the keys on the dial pad in the following manner.
- Press the 7 key 3 times for "S", press Arrow softkey to move to next space
  - Press the 3 key 2 times for "E", press Arrow softkey to move to next space
  - Press the 7 key 2 times for "R", press Arrow softkey to move to next space
  - Press the 8 key 3 times for "V", press Arrow softkey to move to next space
  - Press the 4 key 3 times for "I", press Arrow softkey to move to next space
  - Press the 2 key 3 times for "C", press Arrow softkey to move to next space
  - Press the 3 key 2 times for "E"

The BKSP softkey deletes characters from right to left in the field. The Arrow softkey displays as soon as the first character is entered.

When completed typing in the Group Name, press the **NEXT** softkey. The XFR DN screen will display.

**Note:** Follow the same procedure if you want to edit an existing Group Name.

### Specify Transfer (XFR) DN

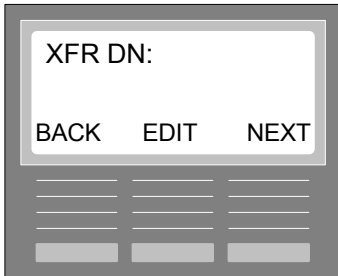

The Transfer DN is a non-physical Norstar DN allowing calls to be transferred to the Group being configured. For example, a receptionist answers a call that was not received as an ACD Call; however, the call can be transferred to ACD by using the Transfer DN. The call then becomes an ACD Call and enters the queue for the Group.

**Note:** Refer to Appendix 3: Norstar Non-physical Directory Number for detailed information.

- 9 To specify the XFR DN, press the **EDIT** softkey. The next screen to display:

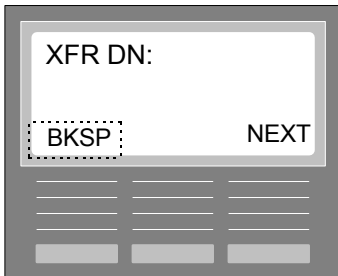

- 10 Type in the **Transfer DN (Extension)** for this Group. For example: if want to type in the numbers "301", you would type in the numbers on the dial pad in this manner:

- Press the 3 key 1 time for "3"
- Press the 0 key 1 time for "0"
- Press the 1 key 1 time for "1"

The BKSP softkey displays as soon as first number is entered and can be used to delete numbers from right to left in the field.

- 11 When completed typing in the XFR DN, press the **NEXT** softkey. The Wrap Dur screen will display.

**Note:** Follow the same procedure if you want to edit an existing XFR DN.



## Specify Wrap Duration



Wrap Duration is the length of time an Agent is provided to wrap up after completing an ACD Call. Specify this time period in seconds (0-99). If Prompted Categorization is being used, a minimum 10 second wrap is required.

**12** To specify a Wrap Duration, press the **EDIT** softkey. The next screen to display:



**13** Type in the **Wrap duration** for Agents in this Group. For example: if want to type in the numbers “30” (30 seconds), you would type in the numbers on the dial pad in this manner:

- Press the 3 key 1 time for “3”
- Press the 0 key 1 time for “0”

The BKSP softkey displays after first number is entered and can be used to delete numbers from right to left in the field.

**14** When completed typing in the Wrap Duration, press the **NEXT** softkey. The Agt Sel screen will display.

**Note:** Follow the same procedure if you want to edit an existing Wrap Dur.

## Specify Longest Idle or Top Down

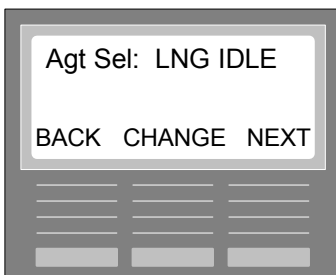

You can specify 1 of 2 types of Agent call answering modes: Longest Idle or Top Down. Longest Idle can be used if you want an ACD call to go to the Agent who has been available the longest since their last call. Top Down can be used if you want an ACD Call to go to the first available Agent closest to the top of the list.

### Longest Idle

## Group Administration

---

- 15** If you want to utilize Longest Idle, make sure it is displaying. The CHANGE softkey toggles between Longest Idle and Top Down. Press the **NEXT** softkey to display the Force Categorization screen (Step 17).

### Top Down

- 16** If you want to utilize Top Down, make sure it is displaying. The CHANGE softkey toggles between Longest Idle and Top Down.

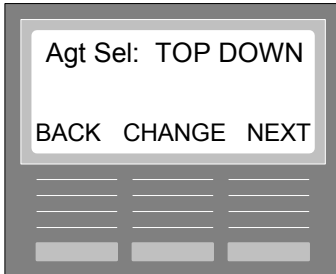

**Note:** Refer to *Agent Administration* chapter, *Add Agents* section for Agent positioning. Press the **NEXT** softkey to display the Prompted Categorization screen.

## Disable/Enable Prompted Categorization

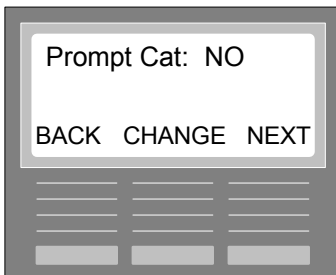

**Notes:** If you do not want to prompt Agents to enter a Category Code upon completing an ACD Call, you will select NO. If you want to prompt Agents to enter a Category Code upon completing an ACD call, you will select YES.

If you disable Prompted Categorization, an Agent can still enter a Category Code after completing an ACD Call by using the Category Feature Code. Refer to the *Performing Agent Functions* chapter, *Categorize* section.

### Disable

- 17** If you want to disable Prompted Categorization, make sure NO is displaying. The CHANGE softkey toggles between NO and YES. Press the **NEXT** softkey to display the Prompted Categorization screen (Step 22).

### Enable

- 18** If you want to enable Prompted Categorization, make sure YES is displaying. The CHANGE softkey toggles between NO and YES.

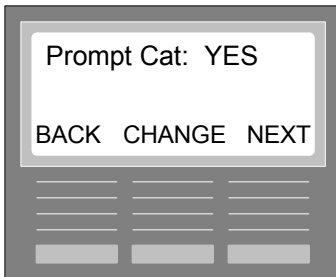

Press the **NEXT** softkey to display the Ovflow Calls screen.

## Specify Overflow Calls

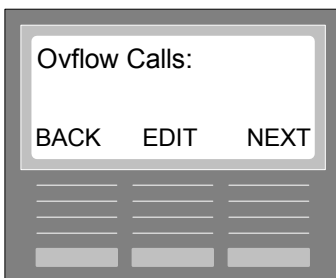

Overflow Calls allows you to designate the maximum number of calls in queue for a Group before overflow to the next Group occurs. For example: if you specify 10 calls as a threshold for Group 1, the 11<sup>th</sup> call that enters the queue for the Group will become available to the Agents in Group 2. However, Agents in Group 1 can still answer the call if they become available.

**19** To specify Overflow Calls, press the **EDIT** softkey. The next screen to display:



**20** Type in the **Overflow Calls** threshold for this Group. For example: if want to type in the number "5" (5 calls), you would type in the number on the dial pad in this manner:

- Press the 5 key 1 time for "5"

The BKSP softkey displays after first number is entered and can be used to delete numbers from right to left in the field.

**21** When completed typing in the Overflow Calls threshold, press the **NEXT** softkey. The Routing screen will display.

**Notes:** To disable Overflow, type in a 0 (zero).

Follow the same procedure if you want to edit existing Ovflow Calls threshold.

### Specify Day Routing Commands

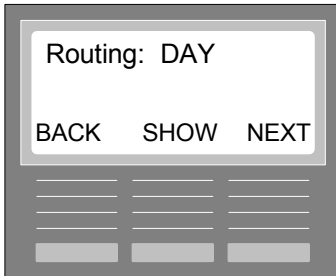

**Notes:** You can use a Feature Code to enable Day Routing and Night Routing for Groups 1 and 2. The default is Night Routing. Refer to Chapter 10 - Routing Session.

Pressing the NEXT softkey displays the Routing: NIGHT screen. Refer to the Specify Night Routing Commands section following this section.

There are **6 Day Routing Command Steps** and **9 Routing Commands** you can utilize to distribute an ACD Call:

**Step 1: DELAY ANSWER**

Delays the answering of an ACD Call for the time period specified. When a call arrives on a Line assigned to a Group, MINUET ACD will refrain from answering until either the Delay Answer time has passed or an Agent becomes available. The Line will ring on the designated Backup Station Set for the delay answer duration.

**Step 2: ANNOUNCEMENT or FORCED ANNOUNCEMENT**

Announcement - plays a recorded announcement that can be interrupted when an Agent becomes available. Forced Announcement - plays a recorded announcement without interruption, even if an Agent is available.

**Step 3: DISTRIBUTE**

Looks to the first available Agent in the Group to send call within the time specified. The Caller will hear the Norstar hold source.

**Step 4: WAIT ANNOUNCEMENT**

Plays a recorded announcement that can be interrupted when an Agent becomes available. This second Announcement is generally used to inform callers that all Agents are still unavailable.

**Step 5: DISTRIBUTE**

Looks to the first available Agent in the Group to send call within the time specified. The Caller will hear the Norstar hold source.

**Step 6: GO TO STEP 4, VMAIL XFR #, XFR TO DN, or GROUP**

- Go To Step 4 - returns caller to Step 4 (Wait Announcement command), executes the command, and then repeats subsequent commands.
- Voice Mail Transfer Number - transfers a call to an initialized and registered mailbox in a Norstar Voice Mail application.
- Transfer To DN - transfers a call to a Norstar DN.
- Group - transfers an ACD Call to a different ACD Group to become a new ACD Call in that Group's queue.

Routing Command Steps	Routing Command	Routing Command Value
Step 1	Delay Answer	Number of seconds (0-99)
Step 2	a) Announcement (or) b) Forced Announcement	Group 1 - # 1    Group 2 - # 4
Step 3	Distribute	Number of seconds (1-999)
Step 4	Wait Announcement	Group 1 - # 2    Group 2 - # 5
Step 5	Distribute	Number of seconds (1-999)
Step 6	Go To Step 4 (or) Voice Mail Transfer (or) Transfer To (or) Group	Step 4 - Wait Announcement Mailbox number Extension number Group number (1 or 2)

**22** To specify Day Routing Commands, press the **SHOW** softkey. The DELAY ANSR screen will display with a 0 second default time period.

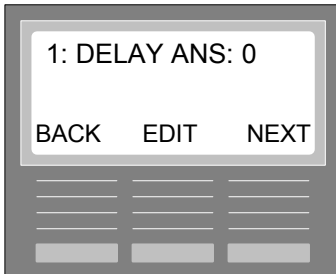

**23** To edit the Delay Answer time period, press the **EDIT** softkey. The next screen to display:



**24** Type in the **Delay Answer** time for Command. For example: if want to type in the numbers “10” (10 seconds), you would type in the numbers on the dial pad in this manner:

- Press the 1 key 1 time for “1”
- Press the 0 key 1 time for “0”

The BKSP softkey displays after first number is entered and can be used to delete numbers from right to left in the field.

**Notes:** If you do not want to use Delay Answer, leave the default 0 (zero) and press NEXT. The Delay Answer time period must be greater than the ICLID Delay time period set in Line Administration.

**25** When completed typing in the Delay Answer time, press the **NEXT** softkey. The ANN screen will display.

**Note:** Follow the same procedure if you want to edit an existing Delay Answer time period.

## Group Administration

---

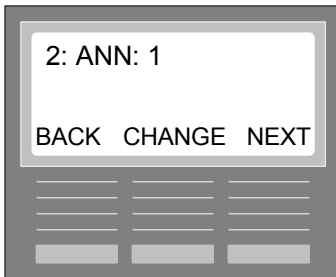

**Notes:** It is recommended that you record all of your Announcements as soon as possible. Refer to Chapter 14 -Performing Agent Functions, Announcement Maintenance section. If an announcement is not recorded, the caller will hear silence over the set until MINUET ACD realizes there is no announcement and continues on to the next Routing Command Step.

Group 1 Announcement or Forced Announcement command is numbered 1. Group 2 Announcement or Forced Announcement is numbered 4.

- 26 If you want to use the Announcement Command, press the **NEXT** softkey. The DISTRIBUTE screen will display (Step 28).
- 27 If you want to use the Forced Announcement Command, press the **CHANGE** softkey. The next screen to display:

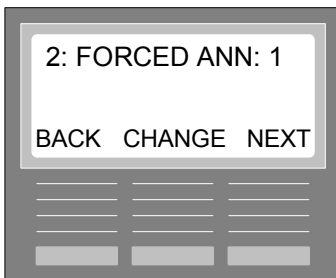

Press the **NEXT** softkey. The DISTRIBUTE screen will display.

**Note:** Follow same procedure if you want to change Commands for this Step.

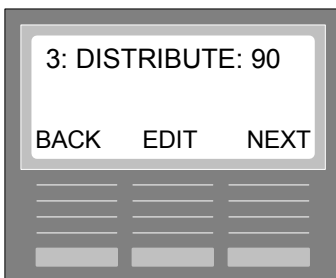

- 28 To specify a Distribute time period, press the **EDIT** softkey. Default is 90 seconds (range 1-999 seconds). The next screen to display:

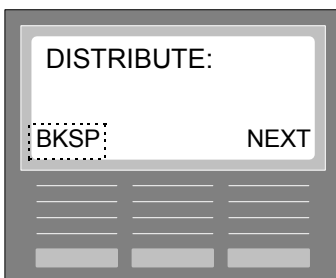

- 29 Type in the **Distribute** time period. For example: if want to type in the numbers "20" (20 seconds), you would type in the numbers on the dial pad in this manner:

- Press the 2 key 1 time for “2”
- Press the 0 key 1 time for “0”

The BKSP softkey displays after first number is entered and can be used to delete numbers from right to left in the field.

- 30** When completed typing in the Distribute time period, press the **NEXT** softkey to display the WAIT ANN screen.

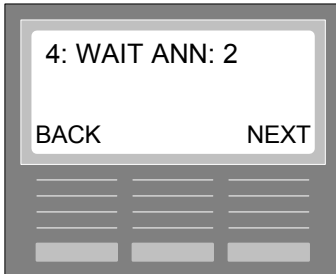

**Notes:** Group 1 Wait Announcement is numbered 2. Group 2 Wait Announcement is numbered 5.

*It is recommended that you record your Announcements as soon as possible. Refer to the Chapter 14 - Performing Agent Functions, Announcement Maintenance section. If you do not record an announcement, the caller will briefly hear silence set until MINUET ACD realizes there is no announcement and continues on to the next Routing Command Step.*

*The Wait Announcement is commonly referred to as a “Courtesy Announcement”. It is used to courteously inform callers that their call is still waiting in queue until the next Agent is available.*

- 31** To continue to the next Routing Command Step, press the **NEXT** softkey. The DISTRIBUTE screen will display.

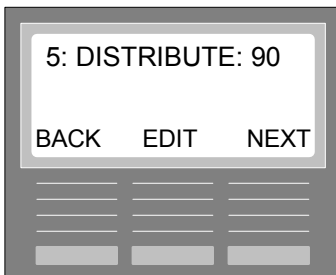

- 32** To specify a Distribute time period, press the **EDIT** softkey. Default is 90 seconds (range 1-999 seconds). The next screen to display:

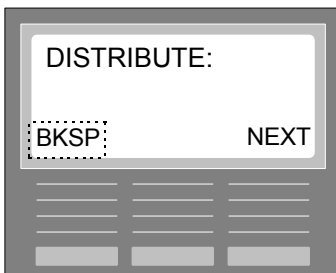

- 33** Type in the **Distribute** time period. For example: if want to type in the numbers “20” (20 seconds), you would type in the numbers on the dial pad in this manner:

- Press the 2 key 1 time for “2”
- Press the 0 key 1 time for “0”

The BKSP softkey displays after first number is entered and can be used to delete numbers from right to left in the field.

## Group Administration

---

- 34 When completed typing in the Distribute time period, press the **NEXT** softkey to display the WAIT ANN screen.

The GO TO STEP 4 screen will display.

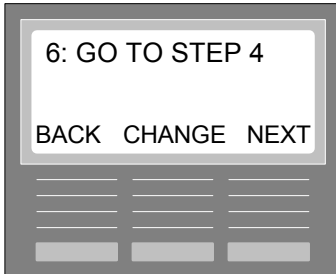

**Note:** Pressing the **CHANGE** softkey will display the remaining Routing Commands for this Step: *VMAIL XFR, XFR TO DN, or GROUP.*

- 35 To use GO TO STEP 4, press the **NEXT** softkey. The Routing: NIGHT screen will display. Refer to Step 45. If you want to use a different Command for Step 6, press the **CHANGE** softkey. The VMAIL XFR screen will display.

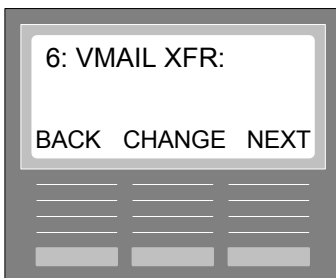

- 36 To transfer a call to a Norstar Voice Mail mailbox number, press the **NEXT** softkey. The next screen to display:

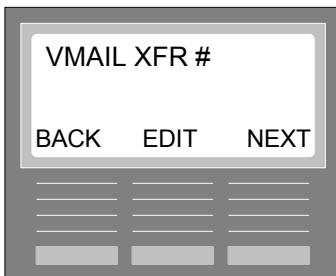

- 37 Press the **EDIT** softkey. The next screen to display:

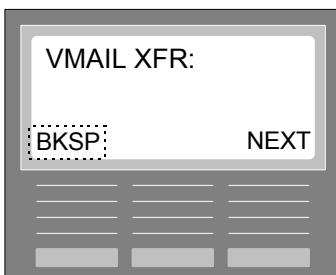

- 38 Type in the **Voice Mail Transfer Mailbox Number**. For example: if want to type in the numbers “210”, you would type in the numbers on the dial pad in this manner:

- Press the 2 key 1 time for “2”
- Press the 1 key 1 time for “1”



- Press the 0 key 1 time for “0”

**If this transfer cannot complete for any reason (e.g., voice mailbox is busy), the call will be returned to the Wait Announcement Command (Step 4).**

The BKSP softkey displays after first number is entered and can be used to delete numbers from right to left in the field.

- 39 To use VMAIL XFR, press the **NEXT** softkey. The Routing: NIGHT screen will display. Refer to Step 45. If you want to use a different Command for Step 6, press the **CHANGE** softkey. The XFR TO DN screen will display.

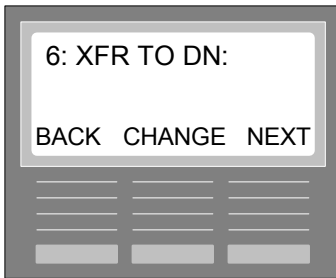

- 40 To transfer a call to a Norstar DN (extension), press the **NEXT** softkey. The next screen to display:



- 41 Press the **EDIT** softkey. The next screen to display:



- 42 Type in the **Transfer to DN (Extension)**. For example: if want to type in the numbers “255”, you would type in the numbers on the dial pad in this manner:

- Press the 2 key 1 time for “2”
- Press the 5 key 1 time for “5”
- Press the 5 key 1 time for “5”

**If this transfer cannot complete for any reason (e.g., DN (extension) is busy), the call will be returned to the Wait Announcement Command (Step 4).**

The BKSP softkey displays after first number is entered and can be used to delete numbers from right to left in the field.

- 43 To use XFR TO DN, press the **NEXT** softkey. MINUET pauses briefly to verify Norstar DN. If it cannot verify, an error beep will sound with the message “Invalid DN”. If this occurs, type in correct Norstar DN. The Routing: NIGHT screen will display. Refer to Step 45. If you want to use a different Command for Step 6, press the **CHANGE** softkey. The GROUP screen will display.

## Group Administration

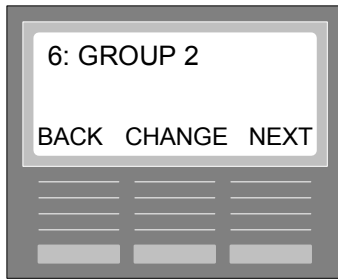

(If editing Group 1)

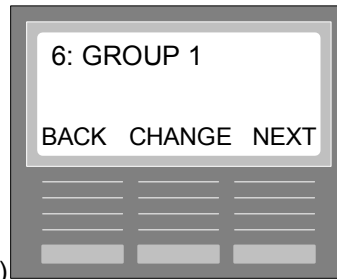

(If editing Group 2)

**44** To use GROUP, press the **NEXT** softkey. The Routing: NIGHT screen will display. Refer to the next Step.

**Note:** Follow the same procedure if you want to edit any of the Routing Commands.

### Specify Night Routing Commands



**Notes:** **Night Routing is enabled as a default and after any type of reboot.** You can use a Feature Code to enable Day Routing or Night Routing. Refer to Chapter 10 - Routing Session - Enable Day or Night Routing.

Pressing the **BACK** softkey displays the Routing: DAY screen. Refer to the Specify Day Routing Commands section preceding this section.

There are **2 Night Routing Command Steps** and **4 Routing Commands** you can utilize to distribute an ACD Call:

#### Step 1: NO ANSWER or NITE ANN

- No Answer - the call will ring on the Backup station Set. ACD will not answer the call.
- Night Announcement - plays a recorded announcement that is forced.

**Note:** If **NO ANSWER** is selected, this will be the only Routing Command for Night Routing. A Step 2 is not necessary. If **NITE ANN** is selected, a Step 2 Routing Command can be used.

#### Step 2: DISCONNECT or VMAIL XFR

Disconnect - ends the call. Voice Mail Transfer Number - transfers a call to an initialized and registered mailbox in a Norstar Voice Mail application.

Routing Command Steps	Routing Command	Routing Command Value
Step 1	a) Nite Announcement (or) b) No Answer	Group 1 - # 3    Group 2 - # 6  N/A
Step 2	a) Disconnect (or) b) Voice Mail Transfer	N/A Mailbox number

**45** To specify Night Routing Commands, press the **SHOW** softkey. The NO ANSWER screen will display.

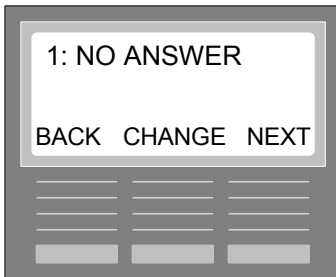

- 46** To use the NO ANSWER Command, press the **NEXT** softkey. The Group Admin screen will display . Refer to Step 53. No other Steps are required for Night Routing.

If you want to use the NITE ANN Command for Step 1 instead of the No Answer Command, press the **CHANGE** softkey. The NITE ANN screen will display.

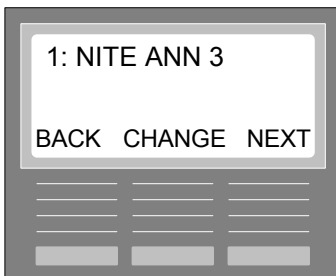

**Notes:** Group 1 Night Announcement is numbered 3. Group 2 Night Announcement is numbered 6. It is recommended that you record your Announcements as soon as possible. Refer to the Chapter 9 - Announcement Maintenance Session. If you do not record an announcement, the caller will briefly hear silence until MINUET ACD realizes there is no announcement and continues on to the next Routing Command Step.

- 47** To use the NITE ANN Command, press the **NEXT** softkey. The DISCONNECT screen will display.

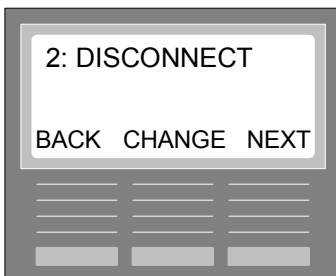

- 48** To use the DISCONNECT Command, press the **NEXT** softkey. The Group Admin screen will display. Refer to Step 53.

If you want to use the VMAIL XFR Command for Step 2 instead of the Disconnect Command, press the **CHANGE** softkey. The VMAIL XFR screen will display.

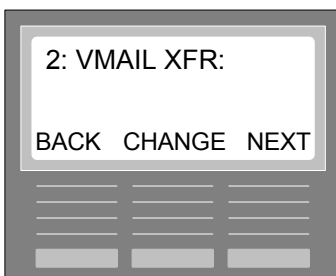

- 49** To transfer a call to a Norstar Voice Mail mailbox number, press the **NEXT** softkey. The next screen to display:

## Group Administration

---

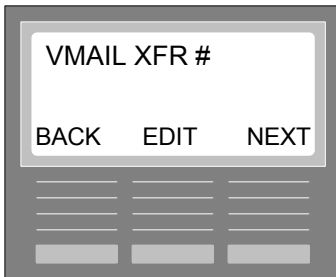

**50** Press the **EDIT** softkey. The next screen to display:

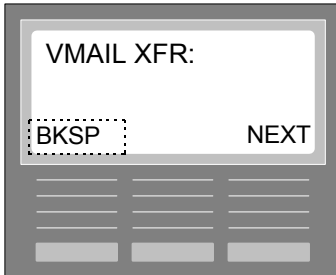

**51** Type in the **Voice Mail Transfer Mailbox Number**. For example: if want to type in the numbers "210", you would type in the numbers on the dial pad in this manner:

- Press the 2 key 1 time for "2"
- Press the 1 key 1 time for "1"
- Press the 0 key 1 time for "0"

**If this transfer cannot complete for any reason (e.g., Voice Mailbox is busy), the call will try to transfer again after a 5 second delay until the transfer can be completed..**

The BKSP softkey displays after first number is entered and can be used to delete numbers from right to left in the field.

**52** To use VMAIL XFR, press the **NEXT** softkey. The Group Admin screen will display. Refer to Step 53.

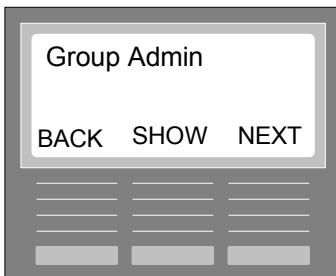

**53** If you have completed Group Administration and want to exit the Administration Session, press the **RI** key. If you want to re-enter Group Administration, press the **SHOW** softkey. If you want to configure Agents, Lines, System functions, or Change Password, refer to the following Chapters. Pressing the **NEXT** softkey will display the Agent Admin screen.

## Update Configuration

If any configuration changes or additions have been made in Group Administration, Agent Administration, Line Administration, and/or System Administration, you will be asked to update these configuration now or later when you exit the Administration Session (Feature 920). If you select LATER, the updates will remain pending until you re-enter the Administration Session. At that point, this message will display "Update pending". When you exit the Administration Session, regardless if more changes or additions have been made, you will again be asked to Update Configurations now or later.

Follow these steps to Update Configurations now or later:

- 1 After you have made changes or additions in the Administration Session either to Group, Agent, Line, or System and try to exit the session, the following screen will display:

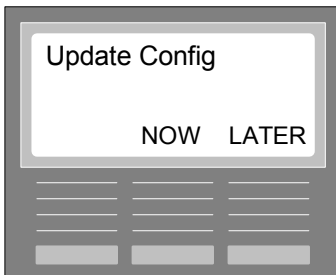

- 2 If you want to Update Configuration now, press the **NOW** softkey. The next screens to display (if configurations can be updated at the present time):

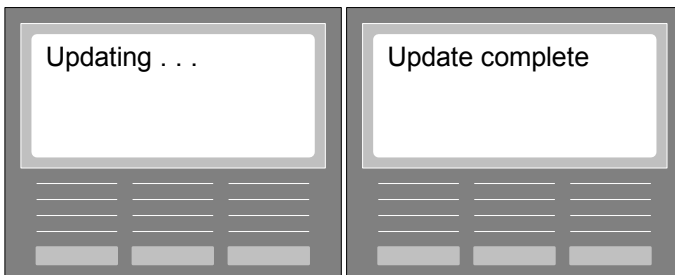

The Date and Time screen will display next. If the Update Configuration cannot be performed at the present time, the following screen will display:



**Note:** There are certain times when an Update Configuration cannot be performed. For example, if you have deleted an Agent but the Agent is still logged in and taking calls, you may receive the "Try again later" message. It is best, therefore, to perform an Update Configuration when your Call Center is least active (e.g., between shifts, after business hours, etc.).

- 3 If you want to Update Configuration later. Press the **LATER** softkey. The "Update pending" screen will briefly display. The Date and Time screen will display next. The next time you enter the Administration Session, the following screen will briefly display:

## Group Administration

---

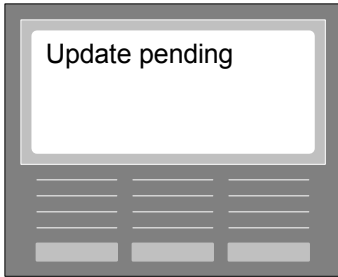

When you next exit the Administration Session, regardless if more configurations have been made or not, the Update Config screen will display asking you if you want to Update Config - NOW or LATER. The Configurations made will not take effect until you finally select NOW.

**Notes:**





# Chapter 5: Agent Administration

In this Chapter you can perform the following **Agent Administration** configurations for 1 and/or 2 **Groups**:

- ▶ **Adding Longest Idle Agent**
  - Enable/Disable Answer Forcing
  - Assign Agent to Group 1 and/or 2
- ▶ **Adding Top Down Agent**
  - Enable/Disable Answer Forcing
  - Assign Agent to Group 1 and/or 2
  - Position Agent in Top Down order
- ▶ **Viewing/Editing an existing Agent**
  - SHOW list of Agents
  - EDIT an Agent
- ▶ **Deleting an Agent**
  - Displaying the Agent to Delete
  - Deleting
- ▶ **Update Configuration**

# Agent Administration Flow Chart

This flow chart provides the menu structure for Agent Administration.

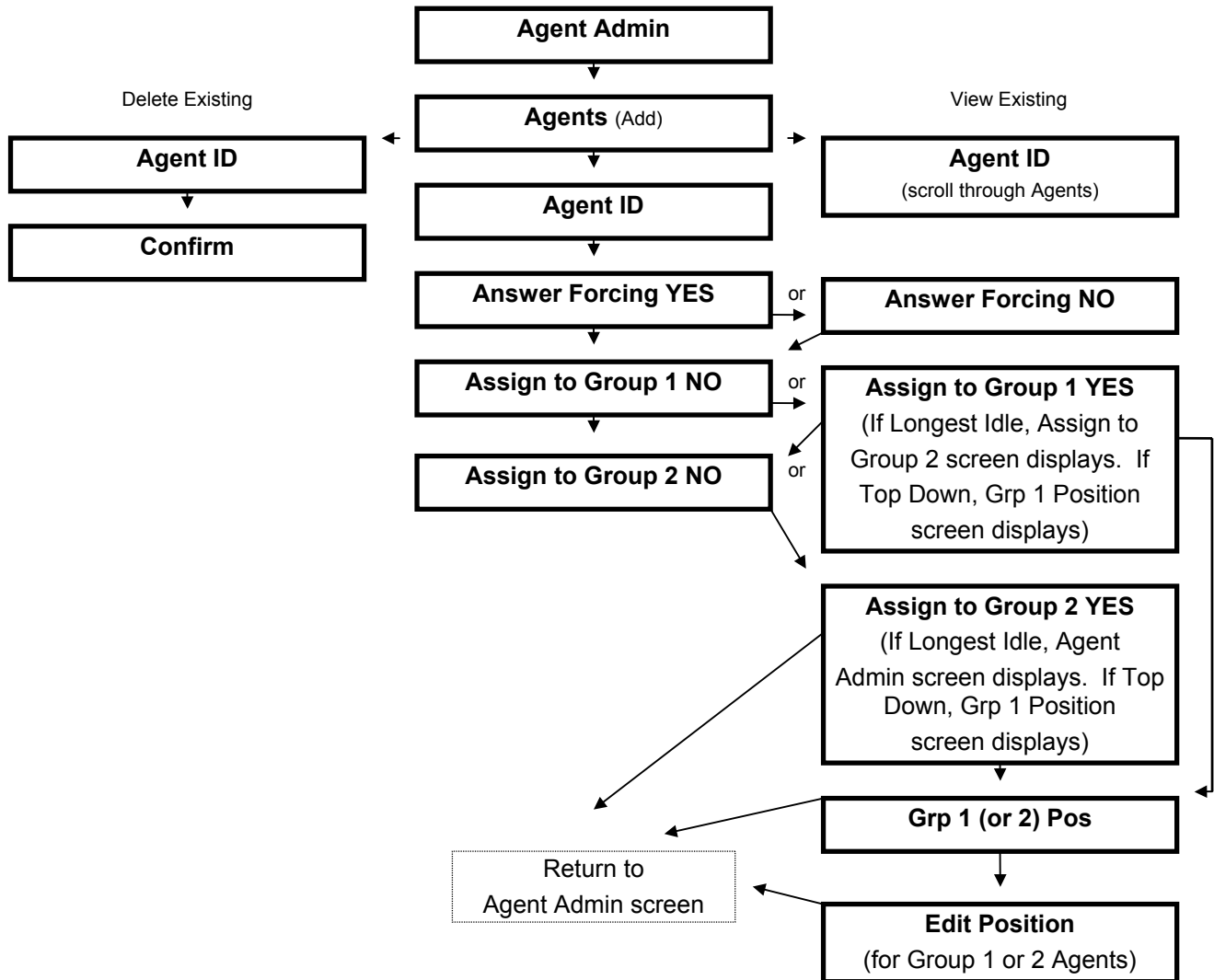

## Configuring an Agent

Using either a **T7316**, **M7310**, or **M7324 Station Set** follow these directions to configure an Agent:

- 1 On the Station Set, press the **Feature** button and then press **920** on the dial pad for the Administration Session Feature Code.

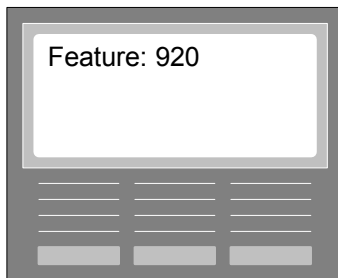

The Administration Session Password screen will display.

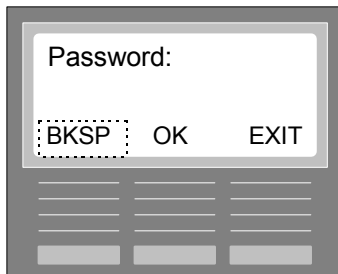

- 2 The **default Password** is **1234**. Refer to the Changing Password Chapter to provide a different Password. On this Password screen, type in the current **Password**. When you start typing, the BKSP (backspace) softkey will display so you can edit your entry from right to left.
- 3 When completed, press the **OK** softkey. The About MINUET screen will display.



- 4 Press the **NEXT** softkey. The Group Administration screen will display.

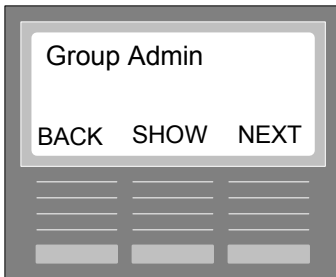

- 5 Press the **NEXT** softkey to display the **Agent Admin** screen



**Note:** If you press the # or the \* key from any of Agent Admin screens, you will be returned to the Agent Admin screen.

## Adding a Longest Idle Agent

In Group Administration you specified for Group 1 and/or 2 whether an Agent would be receiving calls via the Longest Idle or Top Down method. If you are configuring an Agent for the Longest Idle method, follow the directions in this section. If you are configuring an Agent for the Top Down method, refer to the section: Adding a Top Down Agent. Agent ID - 9999 is initially configured.

- 6 Press the **SHOW** softkey to display the Agents screen.



- 7 Press the **ADD** softkey to display the Agent ID screen.



- 8 Type in 2 to 4 numeric characters for Agent ID. For example: if want to type in the numbers "0001", you would type in the numbers on the dial pad in this manner:
- Press the 0 key 1 time for "0"
  - Press the 0 key 1 time for "0"
  - Press the 0 key 1 time for "0"

- Press the 1 key 1 time for “1”

The BKSP softkey displays after first number is entered and can be used to delete numbers from right to left in the field. The CHANGE softkey displays configured Agents.

- 9 When completed, press the **NEXT** softkey. The Ans Forcing screen will display.

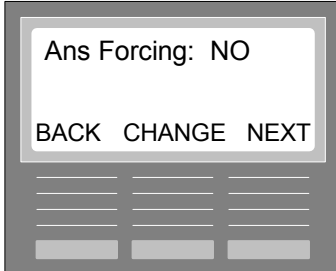

Answer Forcing only applies to those Agents using headsets. The **CHANGE** softkey toggles between NO and YES.

**NO** - Agent accepts a call by pressing the appropriate Station Set keys or lifting the handset.

**YES** - forces a call upon the Agent; a zip tone precedes the call. Agent is required to use a headset.

- 10 When completed, press the **NEXT** softkey. The Assign Grp 1 screen will display.

*Note: These directions use Group 1 as an example. Group 1 is configured with the Longest Idle method.*

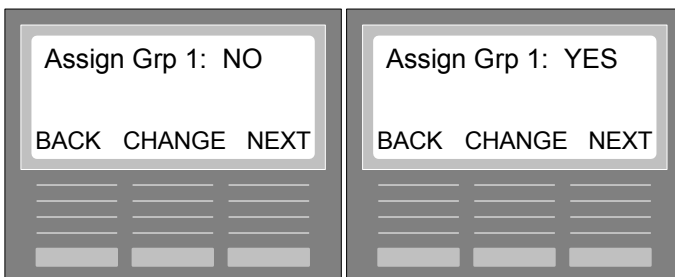

The **CHANGE** softkey toggles between YES and NO. The **NEXT** softkey toggles between Group 1 and Group 2. For this example, press the **CHANGE** softkey to assign the Agent being configured to Group 1. Then press the **NEXT** softkey to display the Assign Group 2 screen.

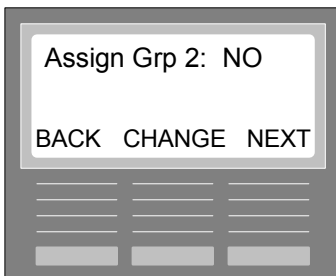

For this example, the Agent will not be assigned to Group 2. Press the **NEXT** softkey to complete this configuration for the Agent and to display the Agent Admin screen.



## Adding a Top Down Agent

In Group Administration you specified for Group 1 and/or 2 whether an Agent would be receiving calls via the Longest Idle or Top Down method. If you are configuring an Agent for the Top Down method, follow the directions in this section. If you are configuring an Agent for the Longest Idle method, follow the directions in the previous section: Adding a Longest Idle Agent. Agent ID - 9999 is initially configured.

**Notes:** Refer to the Top Down Form at the end of this section. You will need to hand print the ordered list of Agents (from first to last) as a reference for later use.

- 1 On the Agent Admin screen, press the **SHOW** softkey to display the Agents screen.



- 2 Press the **ADD** softkey to display the Agent ID screen.



- 3 Type in 2 to 4 numeric characters for Agent ID. For example: if want to type in the numbers "0002", you would type in the numbers on the dial pad in this manner:
  - Press the 0 key 1 time for "0"
  - Press the 0 key 1 time for "0"
  - Press the 0 key 1 time for "0"
  - Press the 2 key 1 time for "2"The BKSP softkey displays after first number is entered and can be used to delete numbers from right to left in the field. The CHANGE softkey displays configured Agents.
- 4 When completed, press the **NEXT** softkey. The Ans Forcing screen will display.

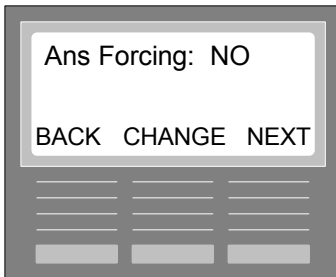

Answer Forcing only applies to those Agents using headsets. The **CHANGE** softkey toggles between NO and YES.

**NO** - Agent accepts a call by pressing the appropriate Station Set keys or lifting the handset.

**YES** - forces a call upon the Agent; a zip tone precedes the call. Agent is required to use a headset.

- 5 When completed, press the **NEXT** softkey. The Assign Grp 1 screen will display.

**Note:** These directions use Group 2 as an example. Group 2 is configured with the Top Down method.

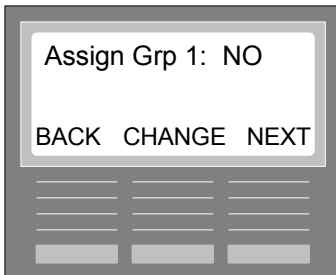

The **CHANGE** softkey toggles between YES and NO. The **NEXT** softkey toggles between Group 1 and Group 2. For this example, the Agent will not be assigned to Group 1. Press the **NEXT** softkey to display the Assign Group 2 screen.

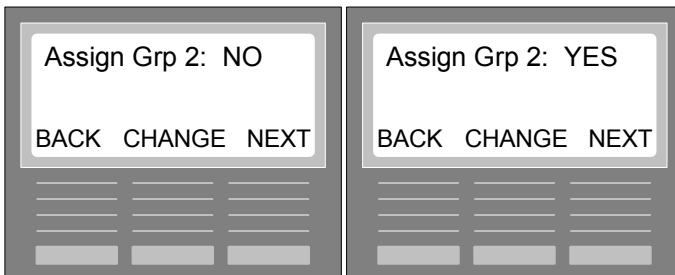

For this example, the Agent will be assigned to Group 2. Press the **CHANGE** softkey to toggle **YES** for Group 2. Then press the **NEXT** softkey to display the Group 2 Pos screen.

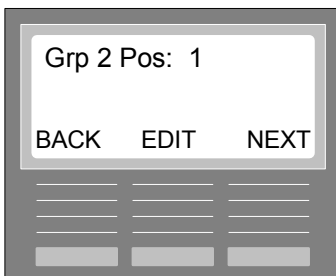

- 6 If you are adding the first Agent, press the **NEXT** softkey and this Agent will be configured and positioned number 1 in the Top Down list. The Agent Admin screen will display so you can continue to configure Agents in order.

If you adding an Agent into a list of previously configured Agents, press the **EDIT** softkey. The next screen to display:

## Agent Administration

---

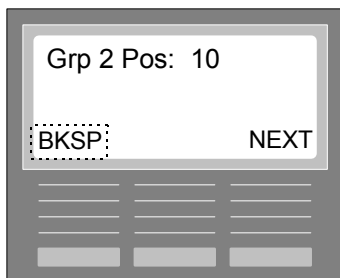

- 7 For this example, there are already 9 Agents configured. This Agent is automatically positioned last. However, if you want to position this Agent in position 5 for example, you will type in 5. Agents 5 through 9 will be moved down one place to become Agents 6 through 10. Press the **NEXT** softkey when completed. The Agent Admin screen will display.

**Notes:** Make sure you reference the Top Down Form on the next page. Whenever you reorder the Agents, make sure this Form is edited to reflect the latest changes.

If your order number is greater than the positions (e.g., 12 and you only have 9), the Agent will be positioned in the 10<sup>th</sup> position.





**Agent Administration**  
**Top Down Form**  
(please make a copy)

Position	Agent ID	Agent Name
1	_____	_____
2	_____	_____
3	_____	_____
4	_____	_____
5	_____	_____
6	_____	_____
7	_____	_____
8	_____	_____
9	_____	_____
10	_____	_____
11	_____	_____
12	_____	_____
13	_____	_____
14	_____	_____
15	_____	_____
16	_____	_____
17	_____	_____

- 18 \_\_\_\_\_
- 19 \_\_\_\_\_
- 20 \_\_\_\_\_

## Viewing/Editing an existing Agent

Follow these steps to either SHOW or EDIT an existing Agent:



- 1 From the Agents screen, press the **SHOW** softkey. The Agent ID screen will display showing the first Agent ID.



- 2 If you want to scroll through and view all of the Agents configured in numeric order, press the **AGT** softkey. Each Agent ID will display in numeric order each time you press AGT. If you want to edit the configuration information for a particular Agent, use the AGT softkey to display that Agent ID and then press the **NEXT** softkey. The Ans Forcing screen will display.
- 3 Follow the steps provided previously for Adding a Longest Idle Agent or a Top Down Agent. Start with the Ans Forcing screen.

## Deleting an Agent

You can delete an existing Agent from a Group. If the Agent is being deleted is a Top Down Agent, make sure you make the edit to the Top Down Form on the previous page. One Agent configured will remain in MINUET; therefore, you will not be able to delete the last Agent.

Follow these steps to delete an Agent:



- 1 On the Agent Admin screen, press the **SHOW** softkey. The Agents screen will display.



- 2 Press the **DEL** softkey to display the Agent ID screen.

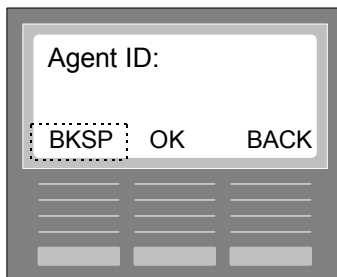

- 3 Type in the Agent ID of the existing Agent you want to delete. For example: if want to type in the numbers "0001", you would type in the numbers on the dial pad in this manner:

- Press the 0 key 1 time for "0"
- Press the 0 key 1 time for "0"
- Press the 0 key 1 time for "0"
- Press the 1 key 1 time for "1"

The BKSP softkey displays after first number is entered and can be used to delete numbers from right to left in the field. If you cannot remember the Agent ID, press the BACK softkey to return to the Agent ID screen, and then use the SHOW key to scroll through the list of Agent IDs.

- 4 When completed, press the **OK** softkey. The Delete Agent screen will display.

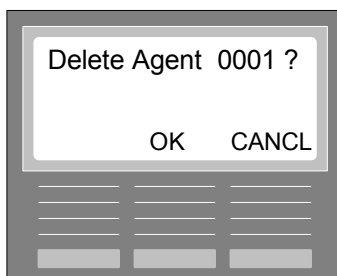

- 5 Press the **OK** softkey to complete the deletion process. The CANCL softkey cancels the process. You will be returned to the Agents screen. Pressing the **#** or **\*** key will return you to the Agent Admin screen.



## Update Configuration

If any configuration changes or additions have been made in Group Administration, Agent Administration, Line Administration, and/or System Administration, you will be asked to update these configuration now or later when you exit the Administration Session (Feature 920). If you select LATER, the updates will remain pending until you re-enter the Administration Session. At that point, this message will display "Update pending". When you exit the Administration Session, regardless if more changes or additions have been made, you will again be asked to Update Configurations now or later.

Follow these steps to Update Configurations now or later:

- 1 After you have made changes or additions in the Administration Session either to Group, Agent, Line, or System and try to exit the session, the following screen will display:



- 2 If you want to Update Configuration now, press the **NOW** softkey. The next screen to display (if configurations can be updated at the present time):



The Date and Time screen will display next. If the Update Configuration cannot be performed at the present time, the following screen will display:



**Note:** There are certain times when an Update Configuration cannot be performed. For example, if you have deleted an Agent but the Agent is still logged in and taking calls, the “Try again later” message may display. It is best, therefore, to perform an Update Configuration when your Call Center is least active (e.g., between shifts, after business hours, etc.).

- 3 If you want to Update Configuration later. Press the **LATER** softkey. The “Update pending” screen will briefly display. The Date and Time screen will display next. The next time you enter the Administration Session, the following screen will briefly display:

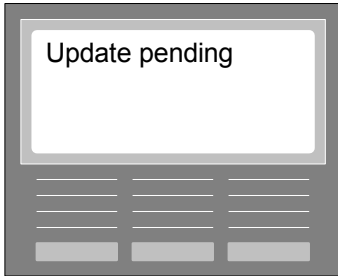

When you next exit the Administration Session, regardless if more configurations have been made or not, the Update Config screen will display asking you if you want to Update Config - NOW or LATER. The Configurations made will not take effect until you finally select NOW.





# Chapter 6: Line Administration

In this Chapter you can perform the following **Line Administration** or **PRI (Primary Rate Interface) Administration** configurations:

- ▶ **Add a Line**
  - **Assign Line to Group**
  - **Enable/Disable ICLID Delay**
- ▶ **Viewing/Editing an existing Line**
  - **SHOW Lines**
  - **EDIT Line**
- ▶ **Deleting a Line**
  - **Displaying the Line to Delete**
  - **Deleting**
- ▶ **Add a PRI**
  - **Assign PRI to Group**
- ▶ **Viewing and reassigning an existing PRI to the other Group**
  - **SHOW PRIs**
  - **Reassigning PRI**
- ▶ **Deleting a PRI**
  - **Displaying the PRI to Delete**
  - **Deleting**
- ▶ **Update Configuration**



## Line and PRI / DNIS / DID Administration Flow Charts

This flow chart provides the menu structure for Line and PRI / DNIS / DID Administration.

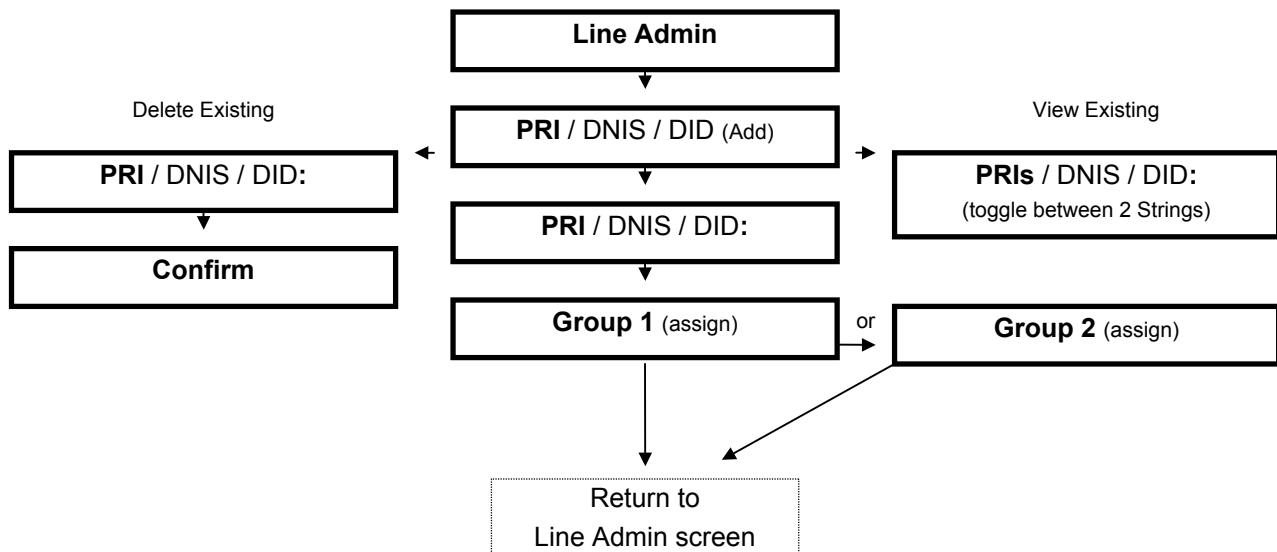
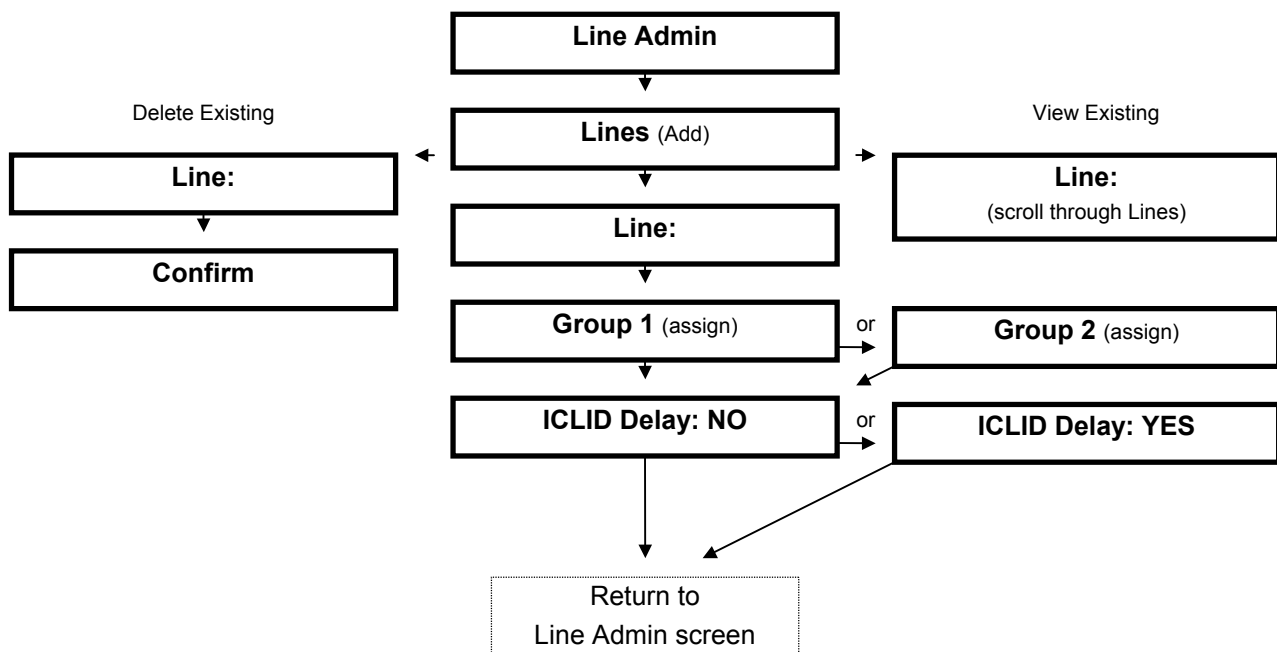

### Configuring a Line and/or PRI / DNIS / DID

The only Norstar Lines you need to configure in MINUET ACD are the Lines exclusively used by MINUET ACD. **The Lines configured for MINUET ACD are not to be used by any other application (e.g., Norstar Voice Mail).** They should be assigned only to the Backup Set. ACD Lines should have a ringing appearance on this Set and should not be assigned anywhere else.

*Note: Lines do not have to be configured if ACD Calls are transferred into a Group from a receptionist or Voice Mail or Minuet DAA is answering a PRI/DNIS/DID string.*

Using either a **T7316, M7310, or M7324 Station Set** follow these directions to configure a Line:

- 1 On the Station Set, press the **Feature** button and then press **920** on the dial pad for the Administration Session Feature Code.

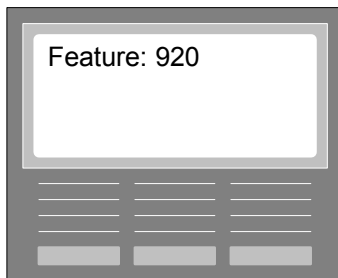

The Administration Session Password screen will display.



- 2 The **default Password** is **1234**. Refer to the Changing Password Chapter to provide a different Password. On this Password screen, type in the current **Password**. When you start typing, the BKSP (backspace) softkey will display so you can edit your entry from right to left.
- 3 When completed, press the **OK** softkey. The About MINUET screen will display.



- 4 Press the **NEXT** softkey. The Group Administration screen will display.

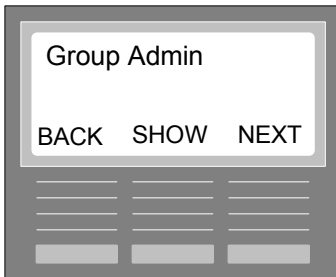

- 5 Press the **NEXT** softkey to display the **Agent Admin** screen



- 6 Press the **NEXT** softkey to display the **Line Admin** screen.

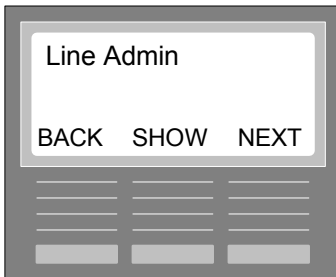

**Note:** If you press the # or the \* key from any of the Line Admin screens, you will be returned to the Line Admin screen.

## Adding a Line

You can add up to 15 Lines and assign them individually to Group 1 or Group 2. Follow these steps to add a Line:

- 7 On the Line Admin screen, press the **SHOW** softkey to display the Lines screen.

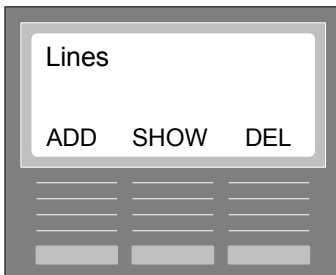

- 8 Press the **ADD** softkey to display the Line and PRI screen.

## Line Administration

---

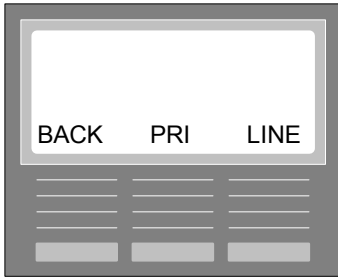

- 9 Press the **LINE** softkey to display the Line number screen.

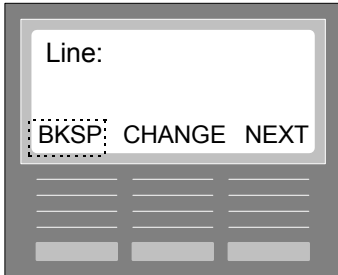

- 10 Type in up to 3 numeric characters for Norstar Line number. For example: if want to type in the numbers "015", you would type in the numbers on the dial pad in this manner:

- Press the 0 key 1 time for "0"
- Press the 1 key 1 time for "1"
- Press the 5 key 1 time for "5"

The BKSP softkey displays after first number is entered and can be used to delete numbers from right to left in the field. The CHANGE softkey displays configured Lines.

- 11 When completed, press the **NEXT** softkey. If you enter less than 3 numeric characters, an error tone with this message will display: "3 Digits Reqr'd". The Group: 1 screen will display.

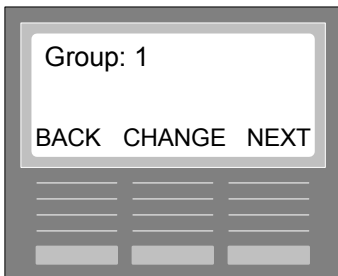

The **CHANGE** softkey toggles between Group 1 and Group 2.

- 12 When completed, press the **NEXT** softkey. The ICLID Delay screen will display.

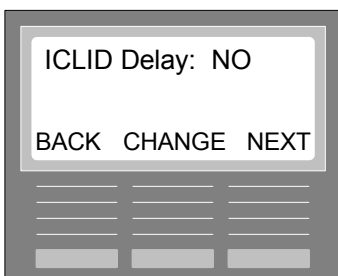

The **CHANGE** softkey toggles between NO and YES (NO is default). If you select YES for ICLID Delay, there will be a 5 second delay when a call arrives on a Line. MINUET ACD will not answer the call until the 5 seconds (default) pass or ICLID information is received by the Norstar. When the Agent's Set receives the ACD Call, the ICLID information for the caller will display for the Agent. If NO is selected, ICLID information will not be displayed and the call will immediately be answered by ACD.

**Note:** Refer to *System Administration* chapter to specify the ICLID Delay time period.

- 13 When completed, select the **NEXT** softkey to complete the configuration and display the Line Admin screen.

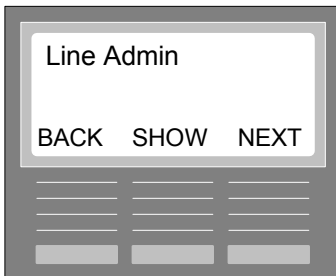

Press the **SHOW** softkey if you want to add more lines.

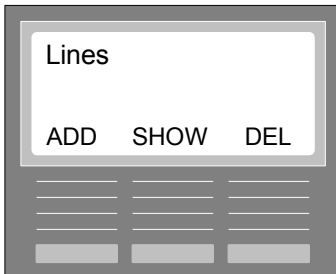

**Note:** If you press the # or the \* key from any of the Line Admin screens, you will be returned to the Line Admin screen.

## Viewing an existing Line and reassigning a Line to the other Group

You can view (SHOW) all of the existing Lines that were configured and you can reassign a Line to the other Group that is configured. Follow these steps:

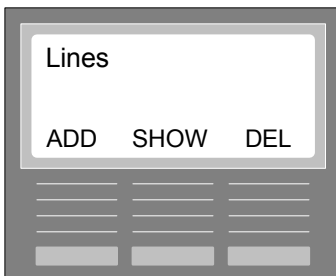

- 1 On the Lines screen press the **SHOW** softkey. The next screen to display:

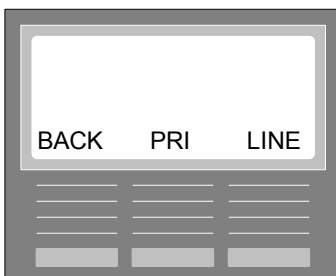

## Line Administration

---

- 2 Press the **LINE** softkey to display the Line number screen.

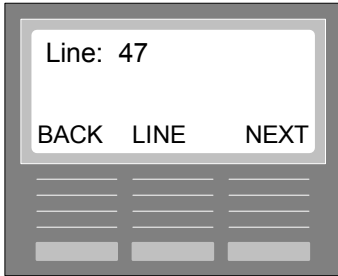

- 3 To view all Lines configured, press the **LINE** softkey. The next Line Number will display in numeric order each time you press the LINE softkey.
- 4 To reassign the Line to the other Group, start by pressing the **NEXT** softkey. The next screen to display is the Group screen to which the Line was assigned. Press the **GRP** softkey to toggle to the other Group and then **press** the **NEXT** softkey. The specified Line will be reassigned to the other Group.

## Deleting a Line

You can delete an existing Line. Follow these steps:

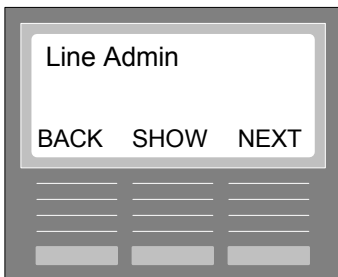

- 1 On the Line Admin screen, press the **SHOW** softkey. The Lines screen will display.

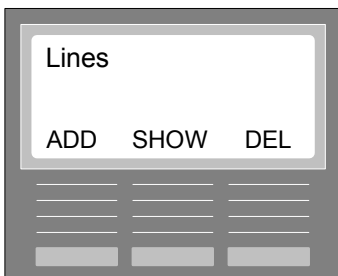

- 2 On the Lines screen, press the **DEL** softkey. The PRI and Line screen will display.

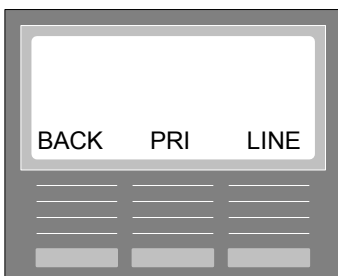

- 3 Press the **LINE** softkey to display the Line number screen.

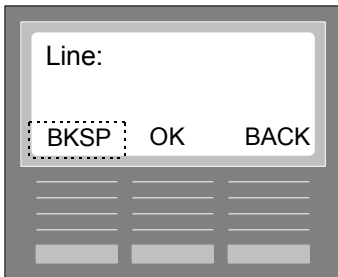

- 4 Type in the Line number of the existing Line you want to delete. For example: if want to delete Line 015, you would type in the numbers on the dial pad in this manner:

- Press the 0 key 1 time for “0”
- Press the 1 key 1 time for “1”
- Press the 5 key 1 time for “5”

The BKSP softkey displays after first number is entered and can be used to delete numbers from right to left in the field. If you cannot remember the Line Number, press the BACK softkey to the Lines screen and then use the SHOW softkey to scroll through the configured Lines.

- 5 When completed, press the **OK** softkey. The Delete Line screen will display.

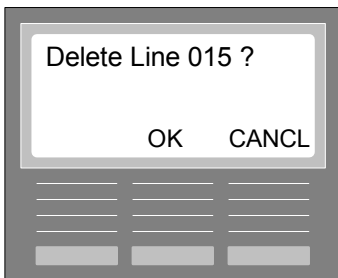

- 5 Press the **OK** softkey to complete the deletion process. The CANCL softkey cancels the process. You will be returned to the Lines screen.

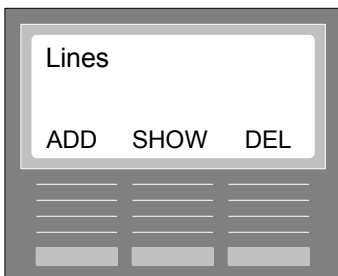

**Note:** If you press the # or the \* key from any of the Line Admin screens, you will be returned to the Line Admin screen.

**Note:** Lines do not have to be configured if ACD Calls are transferred into a Group from a receptionist or Voice Mail or Minuet is answering a PRI/DNIS/DID string.

## Adding a PRI/DNIS/DID Digit String

Minuet supports incoming PRI, DNIS, and DID digit strings as well as Target Lines. You can add up to 2 digit strings and assign both to Group 1 or Group 2 or 1 string to each Group. You can program the Target Lines received digits on the Norstar. Refer to your Norstar manual.

Follow these steps to add a PRI:

- 1 On the Line Admin screen, press the **SHOW** softkey to display the Lines screen.

## Line Administration

---

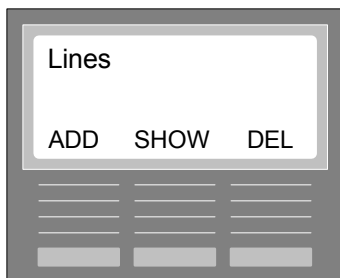

- 2 Press the **ADD** softkey to display the Line and PRI screen.

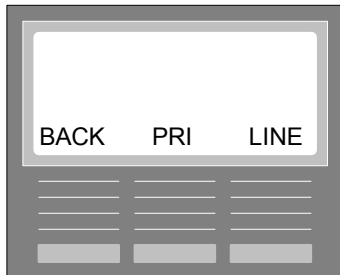

- 3 Press the **PRI** softkey to display the PRI/DNIS/DID digit string screen.

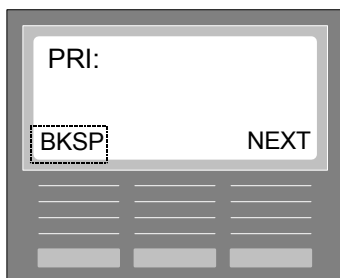

- 4 Type in **up to 10 numeric characters** for **PRI/DNIS/DID digit string**. Do not use wildcards. The BKSP softkey displays after first number is entered and can be used to delete numbers from right to left in the field.
- 5 When completed, press the **NEXT** softkey. The Group: 1 screen will display.

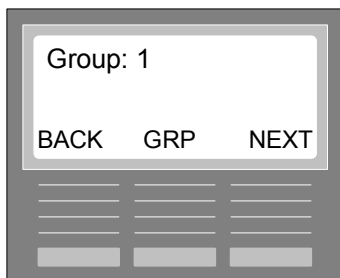

The **GRP** softkey toggles between Group 1 and Group 2.

- 6 When completed, press the **NEXT** softkey. You will be returned to the Line Admin screen to add another PRI/DNIS/DID digit string or reassign an existing PRI/DNIS/DID digit string. Follow the same directions.



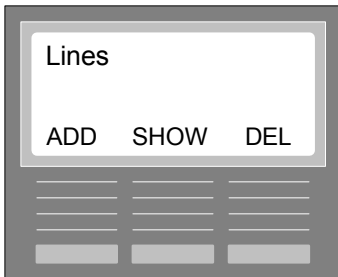

*Note: If you press the # or the \* key from any of the Line Admin screens, you will be returned to the Line Admin screen.*

## Viewing a PRI/DNIS/DID Digit String and reassigning an existing PRI/DNIS/DID Digit String to a Group

You can view (SHOW) the existing PRI/DNIS/DID digit strings that were configured and you can reassign an existing PRI/DNIS/DID digit string to the other Group that is configured. Follow these steps:

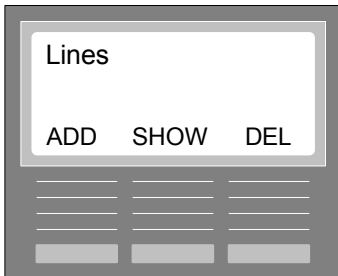

- 1 On the Lines screen press the **SHOW** softkey. The next screen to display:

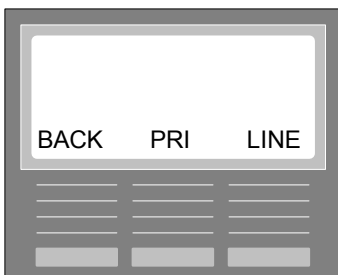

- 2 Press the **PRI** softkey to display the first PRI/DNIS/DID digit string that was configured.

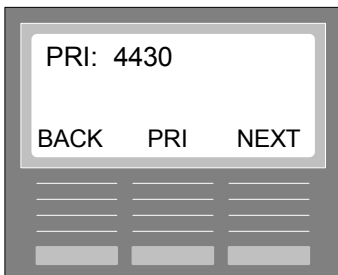

- 3 To view the other PRI/DNIS/DID digit string, press the **PRI** softkey. The last PRI/DNIS/DID digit string will display. Press the PRI softkey again if you want to toggle back to the first PRI digit string configured.
- 4 To reassign the PRI/DNIS/DID digit string to the other Group, press the **NEXT** softkey. The next screen to display is the Group screen to which the PRI/DNIS/DID digit string was assigned. Press the **Grp**

softkey to toggle to other Group. Then press the **NEXT** softkey to reassign the PRI/DNIS/DID digit string to that Group.

### Deleting a PRI/DNIS/DID digit string

You can delete an existing PRI/DNIS/DID digit string. Follow these steps:

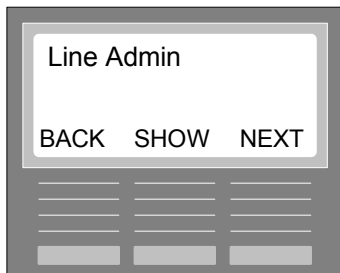

- 1 On the Line Admin screen, press the **SHOW** softkey. The Lines screen will display.

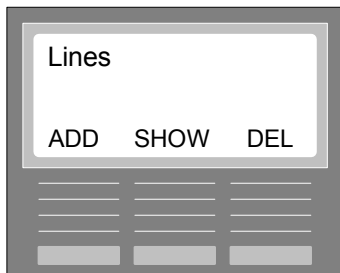

- 2 On the Lines screen, press the **DEL** softkey. The PRI and Line screen will display.

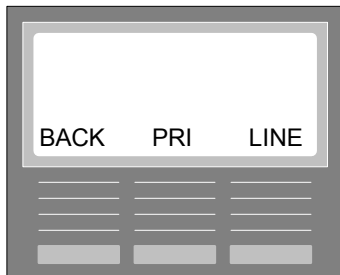

- 3 Press the **PRI** softkey to display the PRI/DNIS/DID number screen.

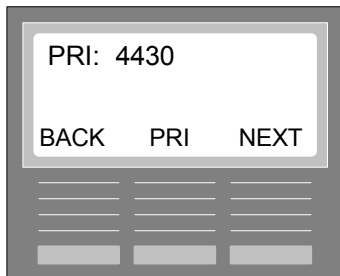

- 4 The first PRI/DNIS/DID digit string will display. If you want to delete this PRI/DNIS/DID, press the **NEXT** softkey. If you want to delete the 2<sup>nd</sup> PRI/DNIS/DID, press the PRI softkey to display it and then press the NEXT softkey. The confirmation screen will display.

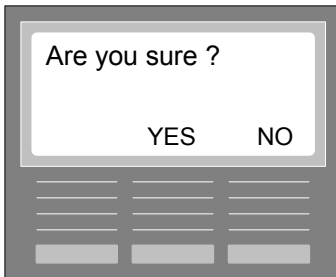

- 5 Press the **YES** softkey to complete the deletion process. The NO softkey cancels the process. You will be returned to the Lines screen.

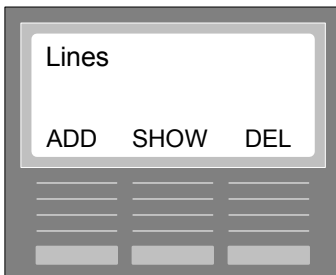

**Note:** If you press the # or the \* key from any of the Line Admin screens, you will be returned to the Line Admin screen.

**Note:** Once you have deleted a PRI/DNIS/DID digit string, you can add another string.

## Update Configuration

If any configuration changes or additions have been made in Group Administration, Agent Administration, Line Administration, and/or System Administration, you will be asked to update these configuration now or later when you exit the Administration Session (Feature 920). If you select LATER, the updates will remain pending until you re-enter the Administration Session. At that point, this message will display "Update pending". When you exit the Administration Session, regardless if more changes or additions have been made, you will again be asked to Update Configurations now or later.

Follow these steps to Update Configurations now or later:

- 1 After you have made changes or additions in the Administration Session either to Group, Agent, Line, or System and try to exit the session, the following screen will display:

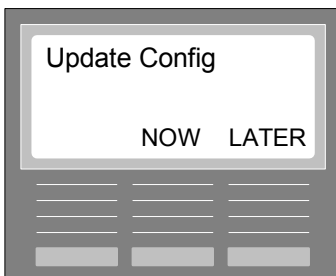

- 2 If you want to Update Configuration now, press the **NOW** softkey. The next screen to display (if configurations can be updated at the present time):

## Line Administration

---

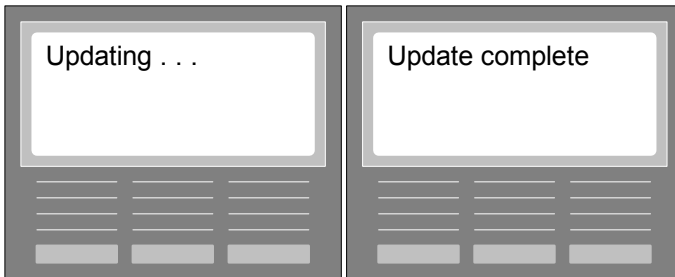

**Important:** When the “Update complete” message displays, the configured Lines are ready for use and MINUET ACD will answer those Lines when it is in operation.

The Date and Time screen will display next. If the Update Configuration cannot be performed at the present time, the following screen will display:



**Note:** There are certain times when an Update Configuration cannot be performed. For example, if you have deleted an Agent but the Agent is still logged in and taking calls, the “Try again later” message may display. It is best, therefore, to perform an Update Configuration when your Call Center is least active (e.g., between shifts, after business hours, etc.).

- 3 If you want to Update Configuration later. Press the **LATER** softkey. The message will briefly display “Update pending”. The Date and Time screen will display next. The next time you enter the Administration Session, the following screen will display:



When you exit the Administration Session, regardless if more configurations have been made or not, the Update Config screen will display asking you if you want to Update Config - NOW or LATER.

The Configurations made will not take effect until you finally select NOW.



# Chapter 7: System Administration

In this Chapter you can perform the following **System Administration** configurations:

- ▶ **Backup Station Set DN (required)**
- ▶ **Specify ICLID Delay Time Period**
- ▶ **Enable Option (None or Wallboard)**
- ▶ **Specify Login/Logout DN**
- ▶ **Specify Available/Unavailable DN**
- ▶ **Update Configuration**

## System Administration Flow Chart

This flow chart provides the menu structure for Line Administration.

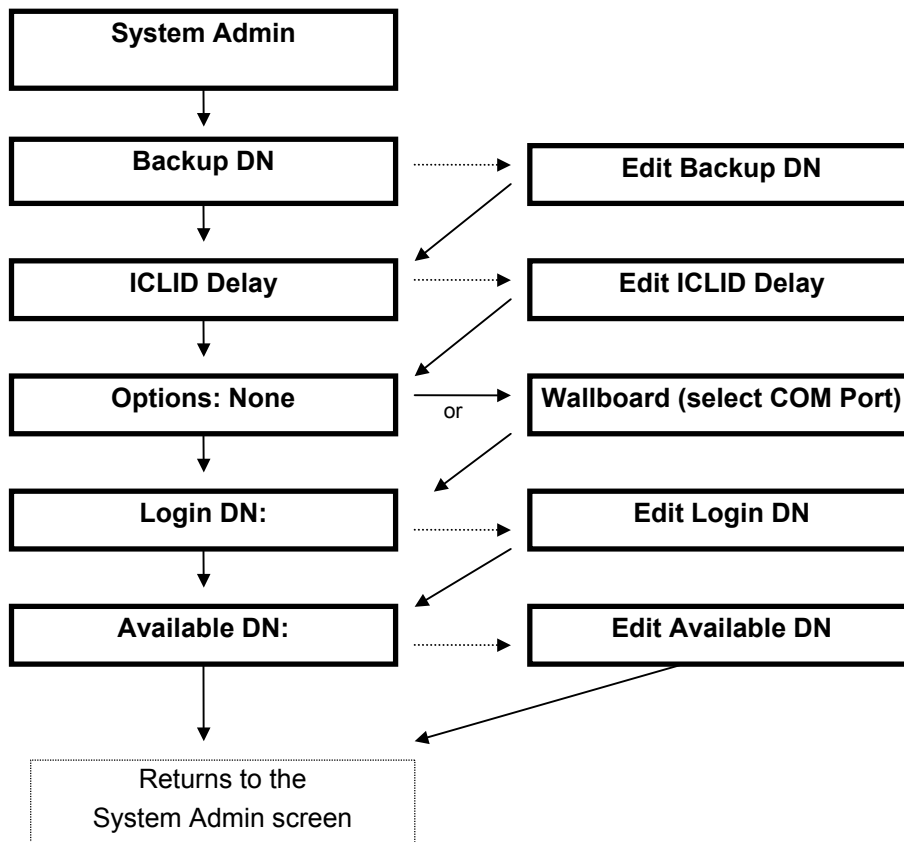

## System Configurations

### Specify Backup Station Set DN

This **required** parameter is the Norstar Directory Number you have assigned to your Backup Station Set. **A Backup Station Set is required for MINUET to operate and to take incoming ACD Calls if ACD becomes unavailable.** MINUET ACD will not operate unless the Backup Station Set DN is configured at the onset. The Backup Set should meet the following requirements:

- ▶ All ACD Lines must be assigned to it with a ringing appearance on this Set.
- ▶ An Agent cannot log in on it.
- ▶ At least 1 Station Set should be dedicated as a backup. Refer to the Norstar Programming Requirements in this Guide for Backup Station Set DN.

Using either a **T7316**, **M7310**, or **M7324 Station Set** follow these directions to specify a the Backup Station Set DN:

- 1 On the Station Set, press the **Feature** button and then press **920** on the dial pad for the Administration Session Feature Code.



The Administration Session Password screen will display.

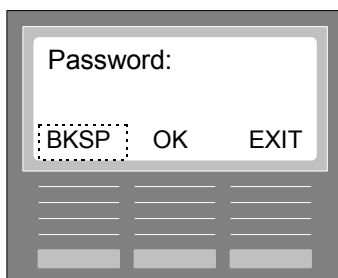

- 2 The **default Password** is **1234**. Refer to the Changing Password Chapter to provide a different Password. On this Password screen, type in the current **Password**. When you start typing, the BKSP (backspace) softkey will display so you can edit your entry from right to left.
- 3 When completed, press the **OK** softkey. The About MINUET screen will display.



- 4 Press the **NEXT** softkey. The Group Administration screen will display.



- 5 Press the **NEXT** softkey to display the **Agent Admin** screen



- 6 Press the **NEXT** softkey to display the **Line Admin** screen.

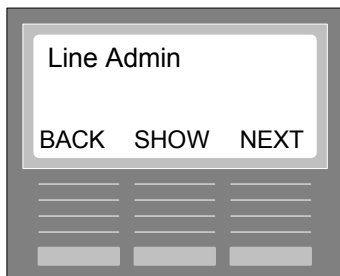

- 7 Press the **NEXT** softkey to display the **System Admin** screen.

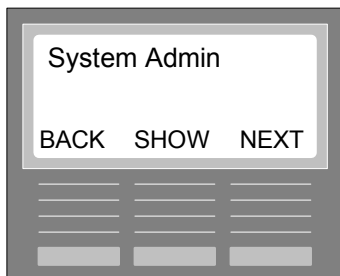

**Note:** If you press the **#** or the **\*** key from any of the System Admin screens, you will be returned to the System Admin screen.

- 8 To specify a Backup Station Set DN, press the **SHOW** softkey. The Backup DN screen will display.



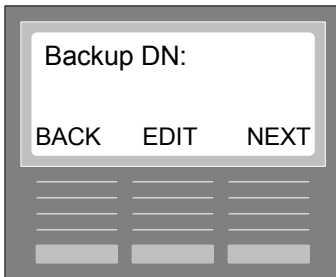

- 9 Press the **EDIT** softkey. The next screen to display:

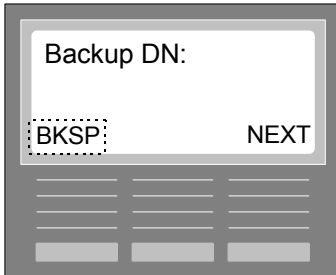

- 10 Type in up to 3-4 numeric characters for the **Backup Station Set DN**. For example: if want to type in the numbers “230”, you would type in the numbers on the dial pad in this manner:

- Press the 2 key 1 time for “2”
- Press the 3 key 1 time for “3”
- Press the 0 key 1 time for “0”

The BKSP softkey displays after first number is entered and can be used to delete numbers from right to left in the field.

## Specify ICLID Delay Time Period

In Line Administration you could enable ICLID Delay for a 5 second default time period. You can lengthen or shorten this time period (5 to 15 seconds). The ICLID Delay time period cannot be greater than the Delay Answer Routing Command time period.

- 11 Press the **NEXT** softkey to display the **ICLID Delay** screen.

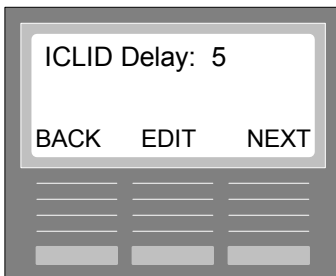

- 12 To change the ICLID Delay time period, press the **EDIT** softkey. The next screen to display:

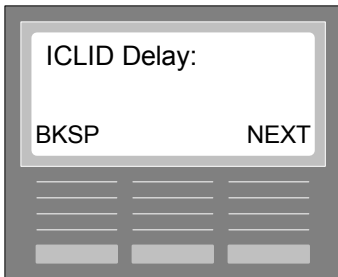

**13** Type in the **ICLID Delay** time period. For example: if want to type in the numbers “10”, you would type in the numbers on the dial pad in this manner:

- Press the 1 key 1 time for “1”
- Press the 0 key 1 time for “0”

The **BKSP** softkey displays after first number is entered and can be used to delete numbers from right to left in the field.

**14** When completed, press the **NEXT** softkey to display the Opts screen.

## Enable Option

On the Opts screen you can enable Wallboard or select None. Refer to Chapter 2, Installation, for directions to install the Wallboard hardware.

Follow these steps to enable Wallboard and select the COM Port to which the Wallboard will be connected:

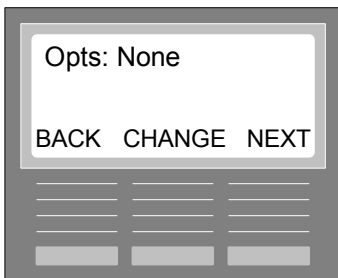

**15** If you do not want to use Wallboard, press the **NEXT** softkey to select **None**. If you want to use Wallboard, press the **CHANGE** softkey. The next screen to display:

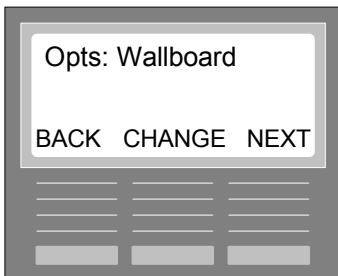

**16** If you want to use Wallboard, press the **NEXT** softkey to display the Group 1 screen.



**17** If you want to view the statistics for **Both Groups**, press the **NEXT** softkey. The Port screen will display.

If you want to view statistics for **Group 1**, press the **CHANGE** softkey to display the Group 1 screen and then press the **NEXT** softkey. The Port screen will display.

If you want to view statistics for **Group 2**, press the **CHANGE** softkey to display the Group 2 screen and then press the **NEXT** softkey. The Port screen will display.

**Note:** *Spectrum's 215R Model is used; it is a single line display utilizing 15 characters*

### Wallboard Statistics Display (example)

#### 215R – Group Number, Calls Queued, Time in Queue, and Number of Unavailable Agents

1	4	0:45	2	2	6	0:33	3
---	---	------	---	---	---	------	---

Group 1 (1<sup>st</sup> line, 1<sup>st</sup> position)

4 = Number of Calls in Queue (2<sup>nd</sup> position)

0:45 = Call in queue for the longest time (3<sup>rd</sup> position)

2 = Number of Agents currently Unavailable (4<sup>th</sup> position)

*(a few seconds will elapse and then the Group 2 statistics will display)*

Group 2 (1<sup>st</sup> line, 1<sup>st</sup> position)

6 = Number of Calls in Queue (2<sup>nd</sup> position)

0:33 = Call in queue for the longest time (3<sup>rd</sup> position)

3 = Number of Agents currently Unavailable (4<sup>th</sup> position)

*(a few seconds will elapse and then the Group 1 statistics will display)*

**18** If you want to utilize the **COM1 Port** on the Applications Module to connect the Wallboard, press the **NEXT** softkey. The Login DN screen will display. If you want to utilize the **COM3 Port** on the Applications Module to connect the Wallboard, press the **CHANGE** softkey. Then Press the **NEXT** softkey to display the Login DN screen.

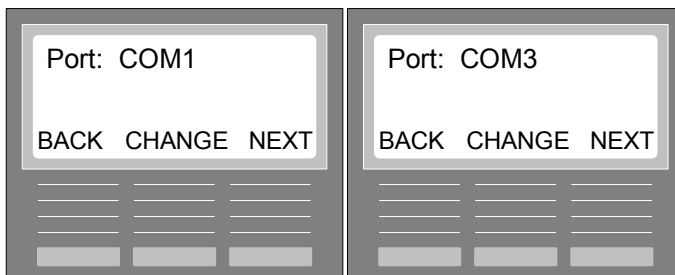

## Specify Login/Logout DN

This parameter is used for the Analog 2500 Set. Agents can use this set to receive ACD Calls; however, the only functions they can perform are: login/logout and available/unavailable. If an Agent is using this set, a Login DN must be specified. Follow these steps:

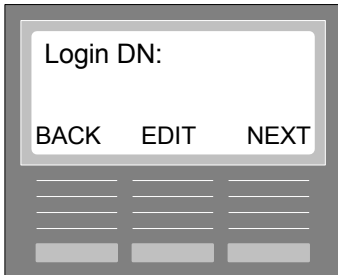

**19** To specify a Login DN, press the **EDIT** softkey. The next screen to display:

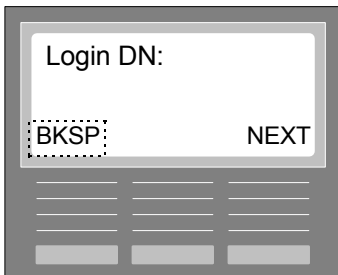

**20** Type in 3-4 numeric characters for the **Login DN**. For example: if want to type in the numbers "303", you would type in the numbers on the dial pad in this manner:

- Press the 3 key 1 time for "3"
- Press the 0 key 1 time for "0"
- Press the 3 key 1 time for "3"

The BKSP softkey displays after first number is entered and can be used to delete numbers from right to left in the field.

**21** When completed, press the **NEXT** softkey to display the Avail DN screen.

**Notes:** Refer to Appendix 3 - Non-physical Norstar Directory Number for details.

Refer to Performing Agent Functions chapter for directions to perform a Login or Logout on an Analog 2500 Set.

## Specify Available/Unavailable DN

This parameter is used for the Analog 2500 Set. Agents can use this set to receive ACD Calls; however, the only functions they can perform are: login/logout and available/unavailable. If an Agent is using this set, an Available DN (Non-physical Norstar Directory Number) must be specified. Follow these steps:

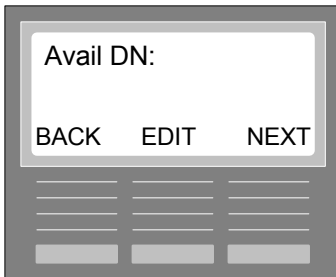

22 To specify an Avail DN, press the **EDIT** softkey. The next screen to display:

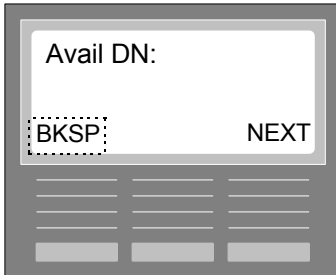

23 Type in up to 3-4 numeric characters for the **Avail DN**. For example: if want to type in the numbers "304", you would type in the numbers on the dial pad in this manner:

- Press the 3 key 1 time for "3"
- Press the 0 key 1 time for "0"
- Press the 4 key 1 time for "4"

The BKSP softkey displays after first number is entered and can be used to delete numbers from right to left in the field.

**Notes:** Refer to Appendix 3 - Non-physical Norstar Directory Number for details.

Refer to Performing Agent Functions chapter for directions to perform a Login or Logout on an Analog 2500 Set.

The NEXT softkey confirms edits and returns you to the System Admin screen.

## Update Configuration

If any configuration changes or additions have been made in Group Administration, Agent Administration, Line Administration, and/or System Administration, you will be asked to update these configuration now or later when you exit the Administration Session (Feature 920). If you select LATER, the updates will remain pending until you re-enter the Administration Session. At that point, this message will display "Update pending". When you exit the Administration Session, regardless if more changes or additions have been made, you will again be asked to Update Configurations now or later.

Follow these steps to Update Configurations now or later:

- 1 After you have made changes or additions in the Administration Session either to Group, Agent, Line, or System and try to exit the session, the following screen will display:

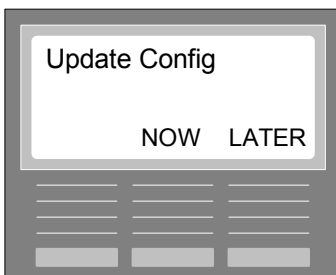

- 2 If you want to Update Configuration now, press the **NOW** softkey. The next screen to display (if configurations can be updated at the present time):



The Date and Time screen will display next. If the Update Configuration cannot be performed at the present time, the following screen will display:



**Note:** There are certain times when an Update Configuration cannot be performed. For example, if you have deleted an Agent but the Agent is still logged in and taking calls, the “Try again later” message may display. It is best, therefore, to perform an Update Configuration when your Call Center is least active (e.g., between shifts, after business hours, etc.).

- 3 If you want to Update Configuration later. Press the **LATER** softkey. The message will briefly display “Update pending”. The Date and Time screen will display next. The next time you enter the Administration Session, the following screen will display:



When you exit the Administration Session, regardless if more configurations have been made or not, the Update Config screen will display asking you if you want to Update Config - NOW or LATER. The Configurations made will not take effect until you finally select NOW.

**Note:** If you have just configured the Backup Station Set DN, you will need to reboot the Norstar Applications Module II for ACD to become active. Refer to the Installation chapter.







# Chapter 8: Change Passwords

In this Chapter you can change the Administration Session Password and/or the Routing Session Password.

The default Administration Session Password (Feature Code 920) and the Routing Session Password (Feature Code 921) is 1234. You can change these Passwords or any other Password you use at a later time. Make sure you write down these Password. If either Password is lost, refer to the Administration Maintenance Session Chapter to Reset Passwords. After changing a Password(s), an Update Configuration is not required.

## Changing Passwords Flow Chart

This flow chart provides the menu structure for Line Administration.

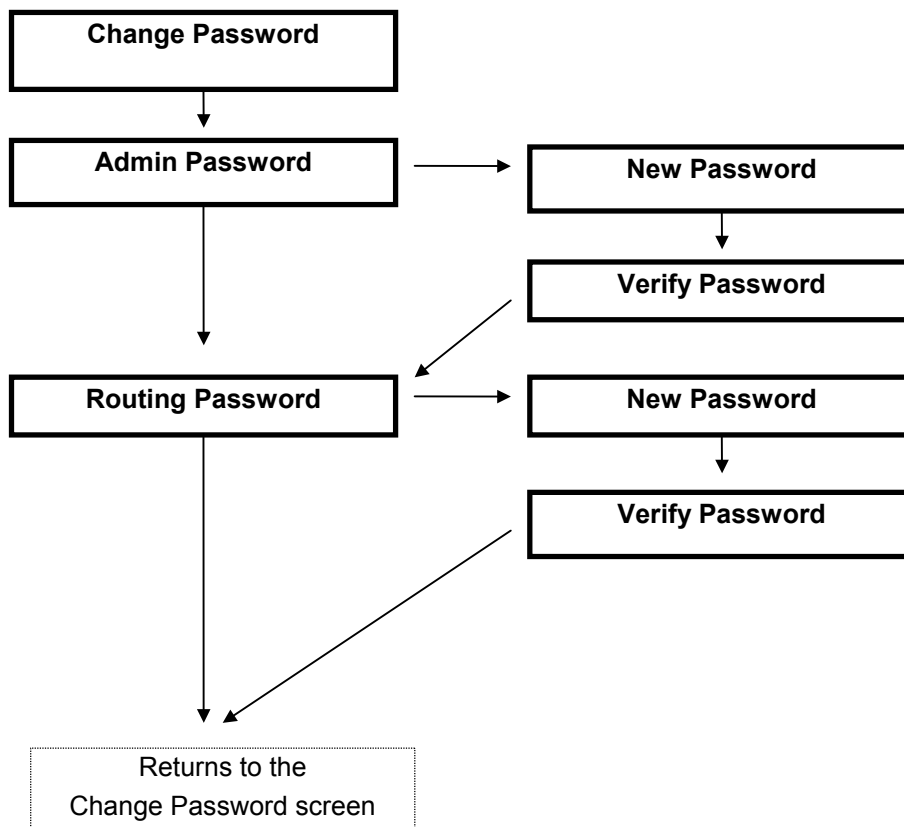

## Changing Administration Session Password

Using either a **T7316**, **M7310**, or **M7324 Station Set** follow these directions to change the Password for this Administration Session:

- 1 On the Station Set, press the **Feature** button and then press **920** on the dial pad for the Administration Session Feature Code.



The Administration Session Password screen will display.



- 2 The **default Password** is **1234**. On this Password screen, type in the current **Password**. When you start typing, the BKSP (backspace) softkey will display so you can edit your entry from right to left.
- 3 When completed, press the **OK** softkey. The About MINUET screen will display.



- 4 Press the **NEXT** softkey. The Group Administration screen will display.

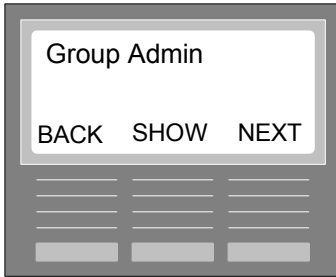

- 5 Press the **NEXT** softkey to display the **Agent Admin** screen

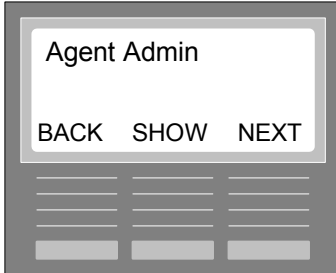

- 6 Press the **NEXT** softkey to display the **Line Admin** screen.

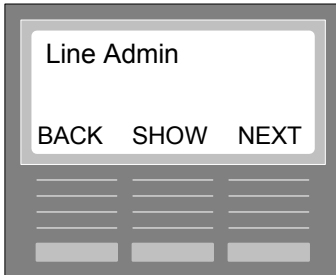

- 7 Press the **NEXT** softkey to display the **System Admin** screen.

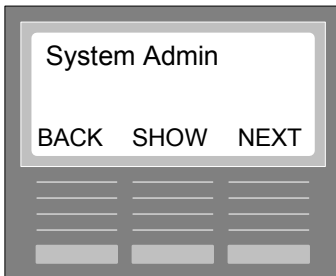

- 8 Press the **NEXT** softkey to display the **Change Password** screen.

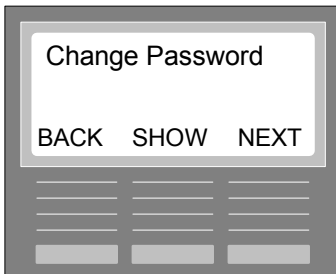

- 9 Press the **SHOW** softkey to display the Admin Password screen.

## Changing Passwords

---

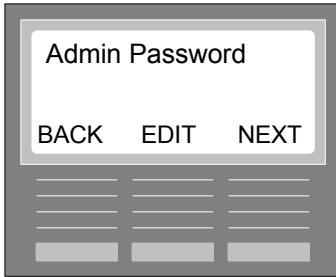

10 Press the **EDIT** softkey to display the New Pswd screen.

**Note:** Pressing the **NEXT** softkey will display the Rout Password screen.

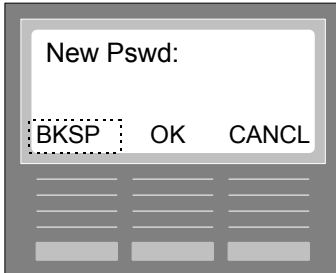

11 Type in up to 12 numeric characters for New Password. For example: if want to type in the numbers “4321”, you would type in the numbers on the dial pad in this manner:

- Press the 4 key 1 time for “4”
- Press the 3 key 1 time for “3”
- Press the 2 key 1 time for “2”
- Press the 1 key 1 time for “1”

The BKSP softkey displays after first number is entered and can be used to delete numbers from right to left in the field. The CANCL softkey returns you to the Admin Password screen.

**Note:** To eliminate a Password, do not enter any digits into the New Pswd field. Just press the OK softkey.

12 When completed, press the **OK** softkey. The Verify Pswd screen will display.

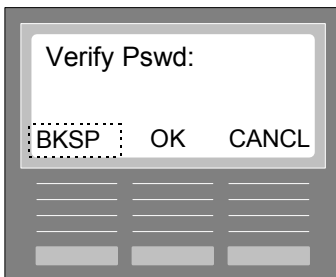

13 Re-type the same **New Password**. When completed, press the **OK** softkey. This confirms the changing of the Administration Session Password and displays the Rout Password screen. The CANCL softkey returns you to the Admin Password screen.

**Note:** To eliminate a Password, do not enter any digits into the Verify Pswd field. Just press the OK softkey.

## Changing Routing Session Password

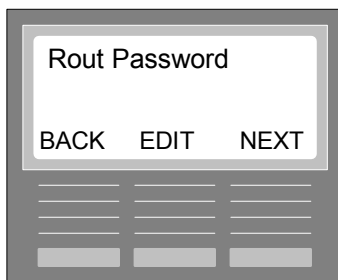

**14** Press the **EDIT** softkey to display the New Pswd screen.

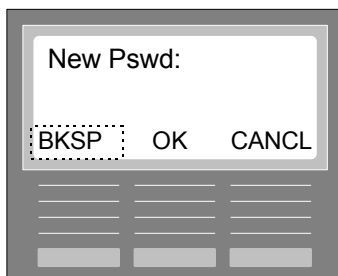

**15** Type in up to 12 numeric characters for New Password. For example: if want to type in the numbers “4321”, you would type in the numbers on the dial pad in this manner:

- Press the 4 key 1 time for “4”
- Press the 3 key 1 time for “3”
- Press the 2 key 1 time for “2”
- Press the 1 key 1 time for “1”

The BKSP softkey displays after first number is entered and can be used to delete numbers from right to left in the field. The CANCL softkey returns you to the Routing Password screen.

**Note:** To eliminate a Password, do not enter any digits into the New Pswd field. Just press the OK softkey.

**16** When completed, press the **OK** softkey. The Verify Pswd screen will display.

## Changing Passwords

---

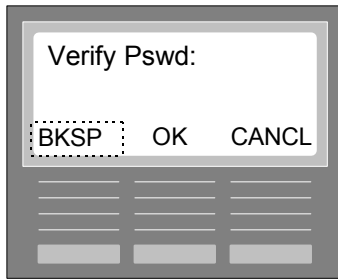

- 17** Re-type the same **New Password**. When completed, press the **OK** softkey. This confirms the changing of the Routing Session Password and displays the Change Password screen. The **CANCL** softkey returns you to the Routing Password screen.

**Note:** *To eliminate a Password, do not enter any digits into the Verify Pswd field. Just press the OK softkey.*



# Chapter 9: Announcement Maintenance Session

## Announcement Maintenance Administrator Function

This Administrator Function allows you to record the announcements for the Announcement Routing Commands specified for Day and/or Night Routing. Refer to the Group Administration chapter for details concerning these Announcements.

Follow these steps to Record an Announcement:

- 1 Press the **ANNC MAINT Key**, or press the **Feature Key** and type in the **Announcement Maintenance Feature Code**. The next screen to display:

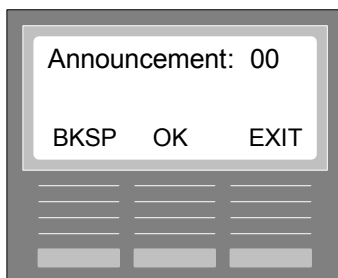

- 2 Type in up to 2 digits, press the **OK Key**, and pick up the handset. The next screen to display:  
If you are recording an Announcement or Forced Announcement for Step 2 in the Day Routing Table, type in the number **1** for Group 1's Announcement or **4** for Group 2's Announcement.  
If you are recording a Wait Announcement for Step 4 in the Day Routing Table, type in the number **2** for Group 1's Announcement or **5** for Group 2's Announcement.  
If you are recording a Nite Announcement for Step 1 in the Night Routing Table, type in the number **3** for Group 1's Announcement or **6** for Group 2's Nite Announcement.

**Note:** Announcements cannot be recorded through a headset.



- 3 Press the **RECORD Key** and the next screen to display:





- 4 When you hear a beep, speak into the handset to record Announcement. When completed, press the **STOP Key**. The next screen to display:



Press RECORD again if you want to re-record announcement. Pressing RECORD when an Announcement is displaying will delete the Announcement. Press PLAY if you want to play the announcement. Press EXIT to return to the Date and Time screen.

Follow these steps to play back an Announcement recorded earlier:

- 1 Press the **ANNC MAINT Key**, or press the **Feature Key** and type in the **Announcement Maintenance Feature Code**. The next screen to display:



- 2 Type in the **Announcement Number** you want to play, and press the **OK Key**.  
The next screen to display:



- 3 Press the **PLAY Key**, and the next screen to display:



**Note:** Pressing RECORD when an Announcement is displaying will delete the Announcement. In this case you will need to immediately re-record the Announcement.

- 4 Press the STOP Key if you want to discontinue playing the Announcement and then press the EXIT Key to quit. A "Terminated" message will briefly display.  
The Date and Time screen will display.

## Announcement Maintenance Session

---

Notes:

# Chapter 10: Routing Session

## Routing Session Flow Chart

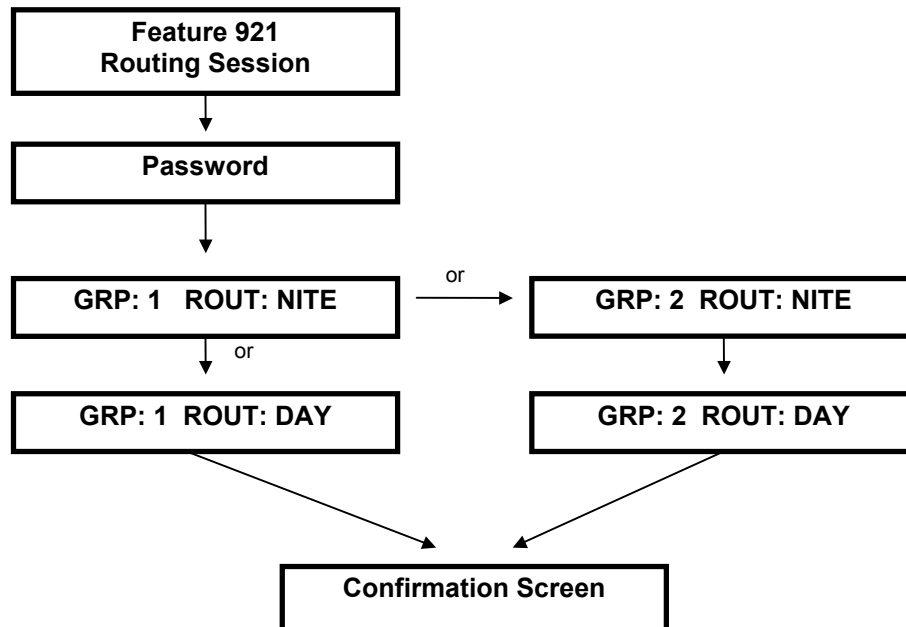

## Enable Day or Night Routing

You must manually enable Day or Night Routing Hours for the start and end of your working shifts. There are two key points to remember when using Day and Night Routing:

- ▶ Night Routing is enabled as the default.
- ▶ When MINUET ACD is restarted, it is started in Night Routing regardless of the time of day.
- ▶ At the start and end of the shift for Day and/or Night Routing, you must enable the Routing for that shift.

Follow these steps to enable Day or Night Routing using either the **T7316**, **M7310**, or **M7324 Station Set**:

- 1 On the Station Set, press the **Feature** button and then press **921** on the dial pad for the Routing Session Feature Code.



The Routing Session Password screen will display.



- 2 The **default Password** is **1234**. Refer to the Changing Passwords chapter to provide a different Password. On this Routing Password screen, type in the current **Password**. When you start typing, the BKSP (backspace) softkey will display so you can edit your entry from right to left.

**Note:** Although the Feature 921 Routing Session Password default (1234) is the same as the Feature 920 Administration Session Password default (1234), these Passwords are independent. Both of these Passwords can be changed in the Changing Passwords chapter of the Administration Session. If either Password is lost, you can reset the Passwords to their original defaults in the Administration Maintenance Session chapter.

- 3 When completed, press the **OK** softkey. The next screen to display is the Routing screen.

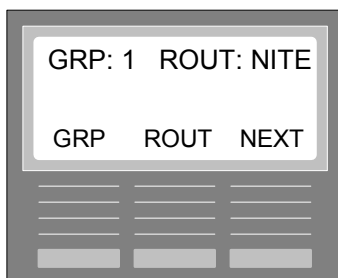

- The **GRP** softkey toggles between **Group 1** and **Group 2**.
  - The **ROUT** softkey toggles between **NITE** and **DAY**.
- 4 Select the Group and the Day or Night Routing for that Group.

## Routing Session

---

- 5 When completed, press the **NEXT** softkey. The next screen to display.

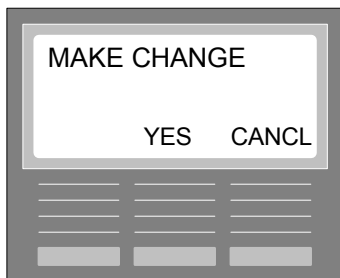

- 6 Press the **YES** softkey to confirm the changes made on the previous Routing screen. The Group screen will re-display. Pressing CANCL will end the feature session. Pressing the RIs key will also end the session; however, changes are not saved.

**Note:** *Calls already in queue for Day Routing, will continue to execute the Day Routing Commands even when Night Routing is enabled (and vice versa).*

Follow the same directions each time you want to change Routing.

**Note:** *Refer to the Administration Statistics Session Chapter to view the ACD Call statistics for the Routing Time Period (the time period when Day or Night Routing is enabled and disabled).*



# Chapter 11: Administration Maintenance Session

In this Chapter you can perform the following operations with the help of a CINTECH Customer Service Technician or a Nortel ITAS Technician:

- ▶ **Logging**
- ▶ **Changing Administration (Cfg) Feature Code (default 920)**
- ▶ **Changing Routing Feature Code (default 921)**
- ▶ **Changing Administration Statistics Feature Code (default 922)**
- ▶ **Changing Group Status Feature Code (default 923)**
- ▶ **Reset Administration Configurations**
- ▶ **Reset Administration Statistics**
- ▶ **Reset All Passwords (Administration Session (920), Routing Session (921), and Administration Maintenance Session (9\*7) Passwords)**
- ▶ **Changing Administration Maintenance Session (9\*7) Password**



# Administration Maintenance Flow Chart

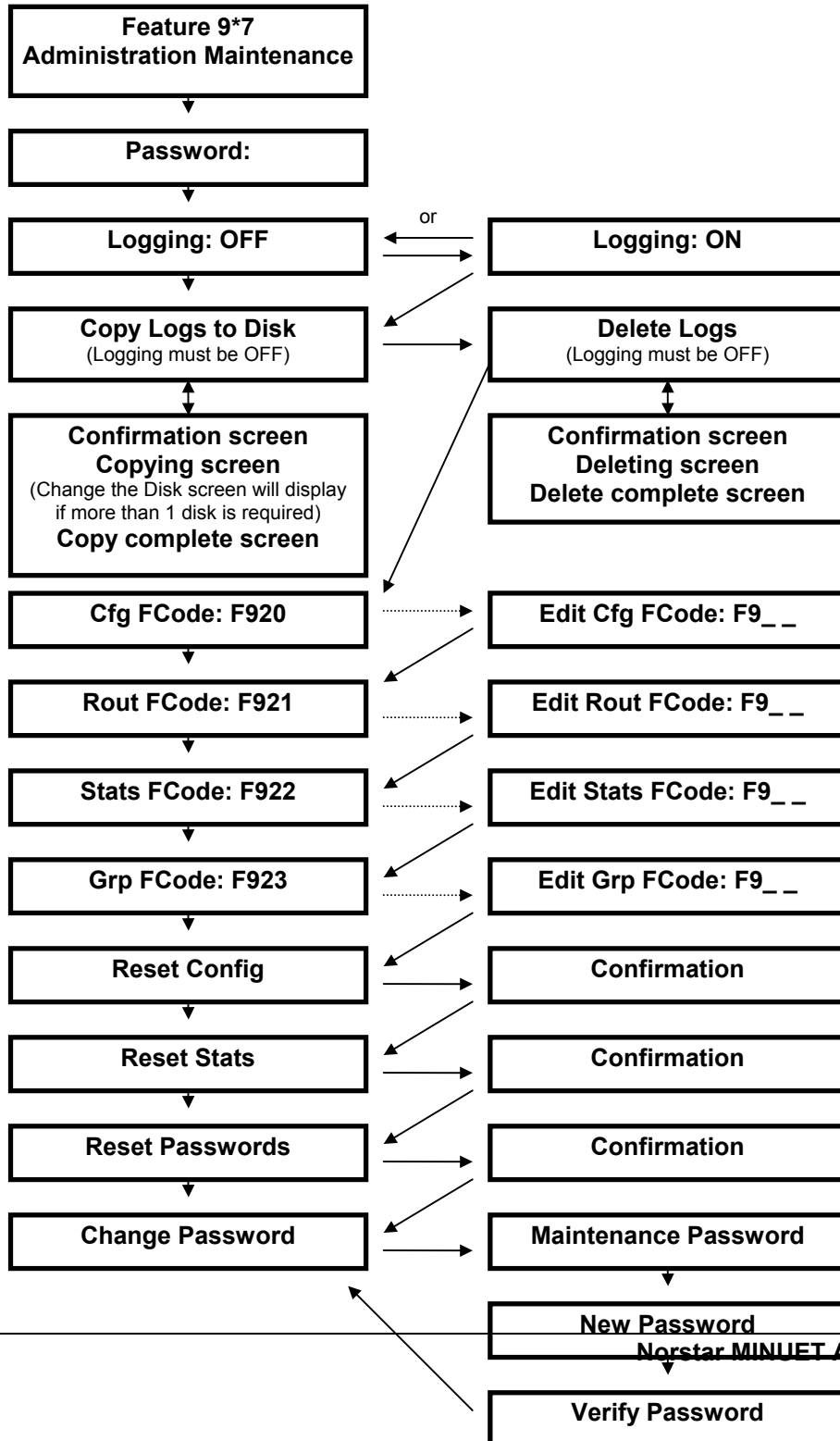

## Logging

The Logging feature is used to capture specific call data files while call processing is active in MINUET ACD. You will only need to utilize this feature when requested by CINTECH Customer Service. For example, you may be experiencing a call processing problem whereas MINUET ACD is not distributing calls properly. After notifying CINTECH Customer Service of the difficulty, a Technician may request that you turn on logging and capture the files that may identify the problem. You will be requested then to copy these Log Files to a floppy or floppies and send them to CINTECH Customer Service.

In this section directions are provided to perform the following:

- ▶ Turn Logging ON, turn Logging OFF
- ▶ Copy Log Files to a Floppy or Floppies
- ▶ Delete Log Files

### Turn Logging ON, turn Logging OFF

Follow these steps to turn Logging ON, exit the Session, re-enter the Session, and turn Logging OFF:

Using either a **T7316**, **M7310**, or **M7324 Station Set** follow these directions to change the Administration Session (Cfg) Feature Codes:

- 1 On the Station Set, press the **Feature** button and then press **9\*7** on the dial pad for the Administration Maintenance Session Feature Code.

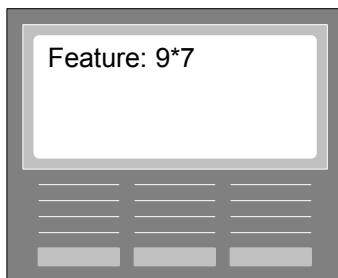

The Administration Maintenance Session Password screen will display.

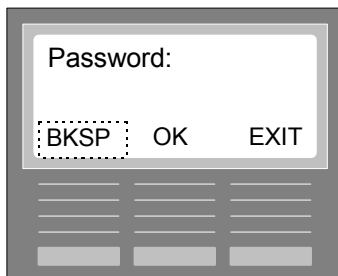

- 2 The **default Password** is **1234**. Refer to the Changing Password section in this chapter to provide a different Password. On this Password screen, type in the current **Password**. When you start typing, the BKSP (backspace) softkey will display so you can delete characters from right to left.
- 3 When completed, press the **OK** softkey. The Logging: OFF screen will display.

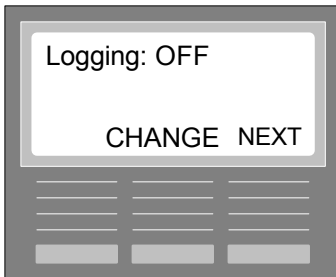

- 4 Press the **CHANGE** softkey to display the Logging: ON screen.

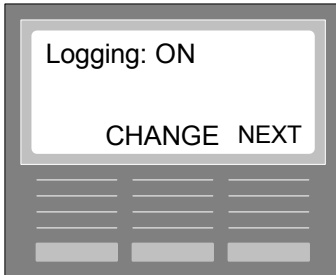

- 5 Logging will start. Your CINTECH Customer Service Technician will tell you how long to continue logging before it is to be turned OFF. Until that time, you can press the **RIS** key to exit this session. When it is time to turn OFF Logging, follow the same steps above to enter the Administration Maintenance Session and the steps to display the Logging: ON screen.
- 6 Press the **CHANGE** softkey to display the Logging: OFF screen.

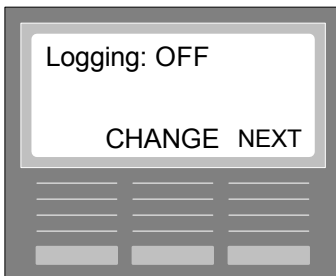

- 7 Press the **NEXT** softkey to display the Cpy logs to disk (copy log files to a floppy or floppies). Logging is now disabled.

### Copy Log Files to a Floppy or Floppies

Logging must be OFF before you can copy Log Files.

Make sure you insert the 3 ½ inch floppy disk in the Applications Module's Disk Drive. If you end up using more than one disk, make sure the disks are labeled properly (e.g., LOG1, LOG2, LOG3, etc.).

Follow these steps to copy Log Files (starting from the Logging: OFF screen)

- 1 Press the **NEXT** softkey on the Logging: OFF screen. The Cpy logs to disk screen will display.

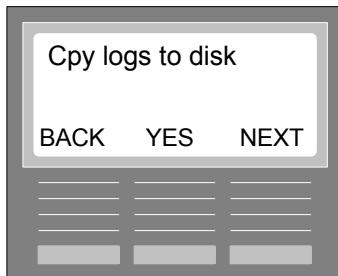

- 2 Press the **YES** softkey. The Confirmation screen will display.

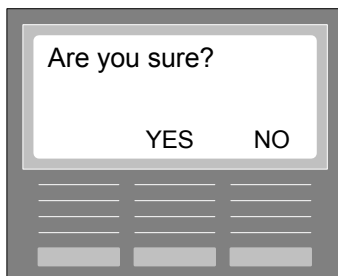

- 3 Press the **YES** softkey (pressing NO returns you to the Cpy logs to disk screen). The next screen to display:



- 4 If more than one disk is required, the next screen to display.



You will have 5 minutes to insert each disk. After you insert the disk in the Applications Module's disk drive, press the **OK** softkey. The Copying screen will re-display. Each time a new disk is needed, the Change the Disk screen will display; and, after the disk is inserted, the Copying screen will re-display. When the copy has completed, this screen will display:



Then the Cpy logs to disk screen will display. Remove the last floppy. Notify CINTECH Customer Service and a Technician will provide directions to mail the log information to CINTECH.

### Delete Log Files

After you have logged files, copied them to floppy, and mailed them to CINTECH; it is best to delete these Log Files to free up hard disk space. Before you delete, however, it is best to notify CINTECH Customer Service to make sure these files are no longer required.

Logging must be OFF before you can delete Log Files.

Follow these steps to delete the Log Files (starting at the Cpy logs to disk screen):

- 1 Press the **NEXT** softkey on the Cpy logs to disk screen. The Delete logs screen will display.

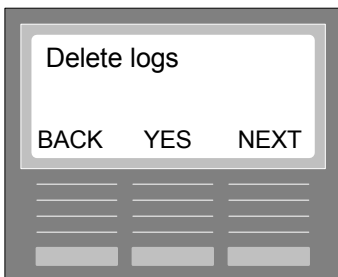

- 2 Press the **YES** softkey. The confirmation screen will display.

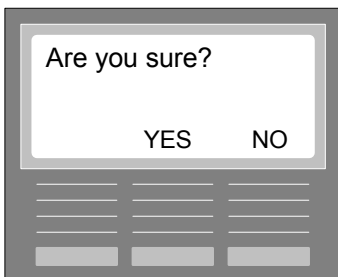

- 3 Press the **YES** softkey. The next screens to display:



- 4 After the Delete complete screen displays, the Delete logs screen will re-display.

# Changing Administration Session (Cfg) Feature Code

If the Administration Session Feature Code (default 920 that is also referred to as the Configuration Feature Code) has been assigned by Norstar for a different feature, **notify a CINTECH Customer Service Technician or a Nortel ITAS Technician to help you change to a different code or remove the application from this code so it can be used by MINUET ACD.**

From the Delete logs screen, follow these steps to change the Administration Session (Cfg) Feature Codes:

- 1 Press the **NEXT** softkey on the Delete logs screen. The Cfg FCode screen will display.

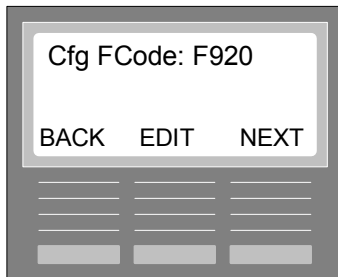

- 2 Press the **EDIT** softkey and the next screen to display:

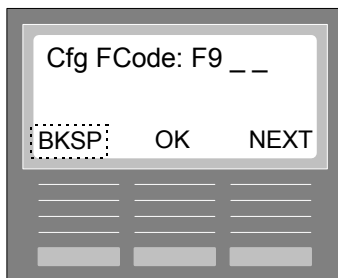

- 3 Type in 2 numeric characters for an available **Feature Code**. After you type in the first character, the BKSP softkey will display allowing you to edit the entry from right to left.
- 4 When completed, press the **OK** softkey to confirm the change and display the previous Cfg FCode screen. Before the next screen displays, a message will display "Changing". If a "Change Failed" error occurs, a Feature Session Table may be in use by another user. Try again later. If the error continues to occur, call CINTECH Customer Service.

**Note:** If the Code you enter has already been assigned by Norstar, an error tone will sound with the message "FCODE in use". Try another code until you locate one that is available. For best results, try a code between the range of 920 through 940.

## Changing Routing Session Feature Code

If the Routing Session Feature Code (default 921) has been assigned by Norstar for a different feature, **notify a CINTECH Customer Service Technician or a Nortel ITAS Technician to help you change to a different code or remove the application from this code so it can be used by MINUET ACD.**

Follow these steps:

- 1 From the Cfg FCode screen, press the **NEXT** softkey. The Rout FCode screen will display.

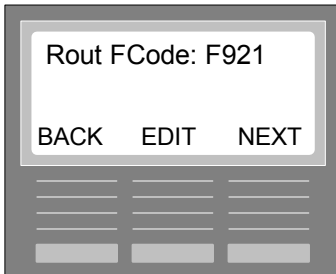

- 2 Press the **EDIT** softkey and the next screen to display:

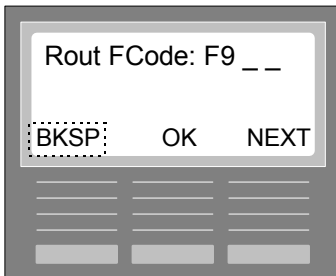

- 3 Type in 2 numeric characters for an available **Feature Code**. After you type in the first character, the BKSP softkey will display allowing you to edit the entry from right to left.
- 4 When completed, press the **OK** softkey to confirm the change and display the previous Reset Config screen. Before the next screen displays, a message will display "Changing". If a "Change Failed" error occurs, a Feature Session Table may be in use by another user. Try again later. If the error continues to occur, call CINTECH Customer Service.

**Note:** If the Code you enter has already been assigned by Norstar, an error tone will sound with the message "FCode in use". Try another code until you locate one that is available. For best results, try a code between the range of 920 through 940.

# Changing Administration Statistics Session Feature Code

If the Administration Statistics Session Feature Code (default 922) has been assigned by Norstar for a different feature, **notify a CINTECH Customer Service Technician or a Nortel ITAS Technician to help you change to a different code or remove the application from this code so it can be used by MINUET ACD.**

Follow these steps:

- 1 From the Rout FCode screen, press the **NEXT** softkey. The Stats FCode screen will display.

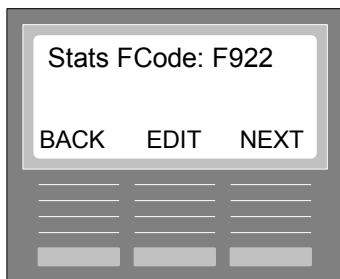

- 2 Press the **EDIT** softkey and the next screen to display:

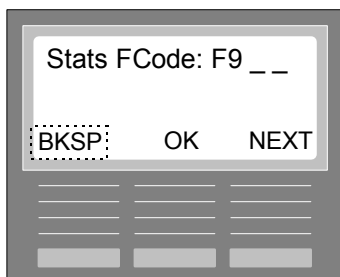

- 3 Type in 2 numeric characters for an available **Feature Code**. After you type in the first character, the BKSP softkey will display allowing you to edit the entry from right to left.
- 4 When completed, press the **OK** softkey to confirm the change and display the previous Reset Config screen. Before the next screen displays, a message will display "Changing". If a "Change Failed" error occurs, a Feature Session Table may be in use by another user. Try again later. If the error continues to occur, call CINTECH Customer Service.

**Note:** If the Code you enter has already been assigned by Norstar, an error tone will sound with the message "FCode in use". Try another code until you locate one that is available. For best results, try a code between the range of 920 through 940.



## Changing Group Status Session Feature Code

If the Group Status Session Feature Code (default 923) has been assigned by Norstar for a different feature, **notify a CİNTECH Customer Service Technician or a Nortel ITAS Technician to help you change to a different code or remove the application from this code so it can be used by MINUET ACD.**

Follow these steps:

- 1 From the Stats FCode screen, press the **NEXT** softkey. The Grp FCode screen will display.

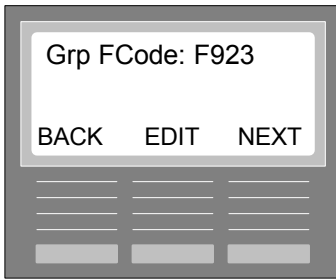

- 2 Press the **EDIT** softkey and the next screen to display:

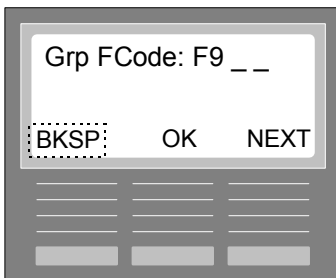

- 3 Type in 2 numeric characters for an available **Feature Code**. After you type in the first character, the BKSP softkey will display allowing you to edit the entry from right to left. Before the next screen displays, a message will display "Changing". If a "Change Failed" error occurs, a Feature Session Table may be in use by another user. Try again later. If the error continues to occur, call CİNTECH Customer Service.
- 4 When completed, press the **OK** softkey to confirm the change and display the previous Reset Config screen.

**Note:** If the Code you enter has already been assigned by Norstar, an error tone will sound with the message "FCode in use". Try another code until you locate one that is available. For best results, try a code between the range of 920 through 940.

# Reset Administration Session Configurations

This function resets **ALL** of the configurations made in the **Administration Session (i.e., Group, Agent, Line, and System Parameters)**! If these configurations are reset, you will need to re-enter all of the configurations in the Administration Session. Therefore, it is important to complete the Configuration Worksheets, found in the Appendices of this Guide, so you will have a guideline copy of your configurations.

**Important, please read before continuing!** When you perform this reset, you will need to exit the Administration Maintenance Session to complete the process. Upon exiting, you will be prompted to either update the reset now or later. If you select now, the reset will complete and all ACD Calls will be sent to the Backup Station Set DN until you re-configure MINUET ACD and update these new configurations. If you select later, ACD Calls will still be sent to the Agents as before; however, the configuration information will not appear on the Administration Session configuration screens. This allows you to start re-configuring MINUET ACD while your call center is still functioning normally. Then, when you have completed these new configurations, the update you perform then will replace the reset update and all configurations will take effect. If you select later, and then later perform the reset update without re-configuring, all ACD Calls will be sent to the Backup Station Set DN until you re-configure. Call CINTech Customer Service if you have any questions concerning this operation.

Follow these steps to Reset Configurations from the Stats Code screen:

- 1 From the **Stats FCode** screen, press the **NEXT** softkey. The Reset Config screen will display.



- 2 If you want to Reset, press the **YES** softkey to display the confirmation screen.

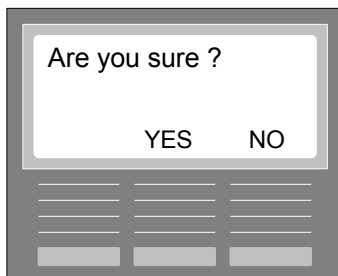

- 3 Press the **YES** softkey if you want to reset all configurations.  
Pressing the **NO** softkey cancels the reset and returns you to the Reset Config screen.  
Pressing **YES** confirms and displays the Reset Stats screen.

To complete Reset Config, follow these steps:

- 1 Press the **Rls** key to exit this session. The Update screen will display.



- 2 If you want to Update Configuration (Reset) now, press the **NOW** softkey. The next screen to display:

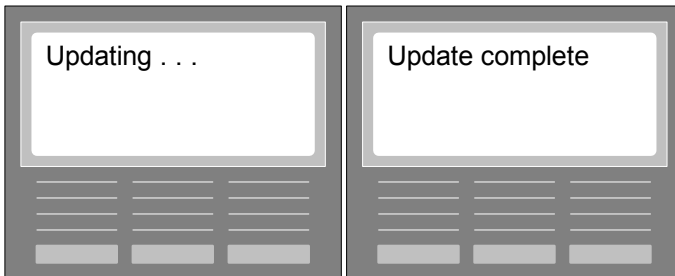

The Date and Time screen will display next. All Configurations will be reset. All calls coming in will go to the Backup Station Set DN (extension). If you want your call center to become fully operational and distribute calls to your Agents, you will need to re-configure MINUET ACD as soon as possible.

- 3 If you want to Update the Reset later, press the **LATER** softkey. The "Update pending" screen will briefly display. Call Processing will continue and call distribution will continue as before the Reset Config was performed. The Date and Time screen will display next. The next time you enter the Administration Session, the following screen will briefly display:



When you next exit the Administration Session, the Update Config screen will display asking you if you want to Update Config - NOW or LATER.

The Reset will not take effect until you finally select NOW.

# Reset Administration Statistics

This function allows you to reset ALL of the Administration Statistics for the specified Date and Time Routing Periods. Once resetting the statistics, they will start accumulating again from the current Date and Time Routing Period.

Follow these steps to Reset Statistics from the Reset Config screen:

- 1 From the **Reset Config** screen, press the **NEXT** softkey. The Reset Stats screen will display.

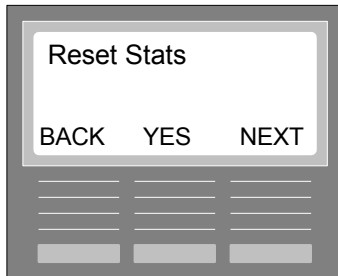

- 2 If you want to Reset, press the **YES** softkey to display the confirmation screen.

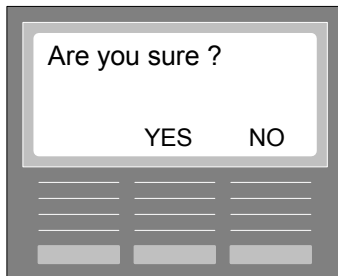

- 3 Press the **YES** softkey if you want to reset the statistics. (Pressing the NO softkey cancels the reset and returns you to the Reset Stats screen)

The next screen to briefly display:

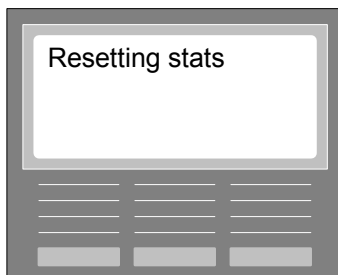

The next screen to display is Reset Passwords.

## Reset All Passwords

If you have lost the Password for either the Administration Session (Feature 920) or the Routing Session (Feature 921), you can utilize this function to reset both Passwords back to the original defaults of 1234. Reset Passwords also resets the Administration Maintenance Session (9\*7) Password back to the original default of 1234. If you reset the Administration and Routing Session Passwords back to their defaults, you can use the Administration Session Change Password feature to change these default Passwords to what you want. You can also use the Change Password feature in this session to change the Administration Maintenance Password to what you want.

**Note:** If you have used the Change Password feature to eliminate (void) a Password for either the Administration, Routing, and/or Administration Maintenance Sessions, a reset will return the no Password(s) to 1234.

Follow these steps to reset all 3 Passwords:

- 1 From the Reset Config screen, press the **NEXT** softkey to display the Reset Passwords screen.

**Note:** If you have performed a Reset Configuration operation and have pressed the YES softkey to confirm, the next screen to display is the Reset Passwords screen.

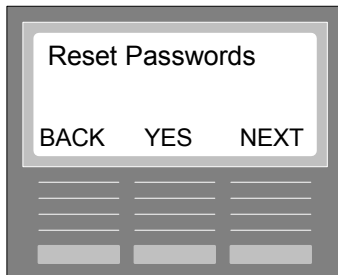

- 2 Press the **YES** softkey. The confirmation screen will display.

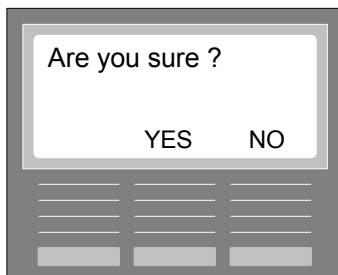

- 3 Press the **YES** softkey to confirm the reset.  
Pressing the NO softkey cancels the reset and returns you to the Reset Passwords screen.  
Pressing YES confirms the reset and displays the Change Password screen.

# Changing Administration Maintenance Session Password (Feature 9\*7)

The default Password for the Administration Maintenance Session Password is 1234. You can change this Password.

Follow these steps:

- 1 From the Reset Passwords screen, press the **NEXT** softkey. The Change Passwords screen will display.

**Note:** If you have performed a Reset Password operation and have pressed the YES softkey to confirm, the next screen to display is the Change Password screen.

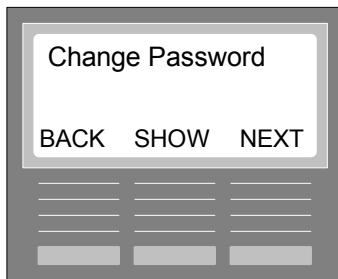

- 2 Press the **SHOW** softkey. The Maint Password screen will display.

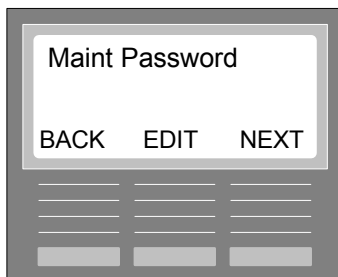

- 3 Press the **EDIT** softkey. The New Pswd screen will display.

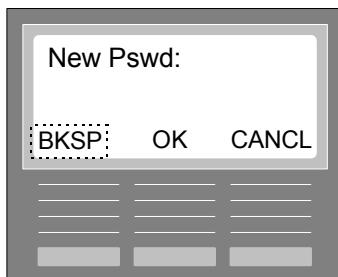

- 4 Type in up to 12 numeric characters for New Password. For example: if want to type in the numbers "4321", you would type in the numbers on the dial pad in this manner:

- Press the 4 key 1 time for "4"
- Press the 3 key 1 time for "3"
- Press the 2 key 1 time for "2"
- Press the 1 key 1 time for "1"

The BKSP softkey displays after first number is entered and can be used to delete numbers from right to left in the field.

**Note:** To eliminate a Password, do not enter any digits into the New Pswd field. Just press the OK softkey.

- 5 When completed, press the **OK** softkey. The Verify Pswd screen will display.

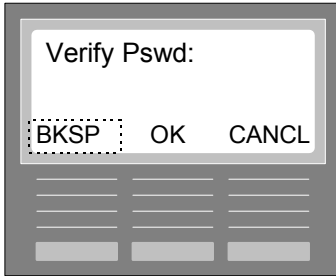

- 6 Re-type the same **New Password**. When completed, press the **OK** softkey.

**Note:** To eliminate a Password, do not enter any digits into the VerifyPswd field. Just press the OK softkey.

Pressing the CANCL softkey cancels the action and returns you to the Cfg FCode screen.

Pressing the OK softkey confirms and displays the Change Password screen.

**Note:** If you forget or lose this Password, you will need to call CINTECH Customer Service 800-944-3901 for a temporary Password (Password Recovery) for the Administration Maintenance Session. When you receive this Password, you will have 24 hours to utilize this Password. When you use this Password to enter the Administration Maintenance Session, follow the Change Administration Maintenance Session Password directions to change the temporary Password to the one you want to use permanently, or use the Reset Passwords feature to reset all Passwords to the defaults of 1234.

## Administration Maintenance Session

---

Notes:





# Chapter 12: Administration Statistics Session

In this Chapter directions are provided to view the following ACD Call Statistics for Group 1 and/or 2:

- ▶ **Number of ACD Calls Answered by Agents for the selected Date and Routing Time Period (# ANSWERED)**
- ▶ **Number of ACD Calls Abandoned by Callers for the selected Date and Routing Time Period (# ABANDONED)**
- ▶ **Number of ACD Calls Disconnected by the Disconnect Night Routing Command for the selected Date and Routing Time Period (# DISCONNECT)**
- ▶ **Average Time Agents took to Answer ACD Calls for the selected Date and Routing Time Period (AV-TIME-ANS)**
- ▶ **Average Time it took Callers to Abandon ACD Calls for the selected Date and Routing Time Period (AV-TIME-ABN)**
- ▶ **Number of ACD Calls taken by Agents per Category Code for the selected Date and Routing Time Period (# CALL/CODE)**

## Administrative Statistics Flow Chart



## Viewing Administration Statistics

If the Administration Statistics Session Feature Code (default 922) has been assigned by Norstar for a different feature, you can specify a different code.

Using either a **T7316**, **M7310**, or **M7324 Station Set** follow these directions to view the Administration Statistics for Group 1 and/or 2:

- 1 On the Station Set, press the **Feature** button and then press **922** on the dial pad for the Administration Statistics Session Feature Code.



The Group 1 screen will display.

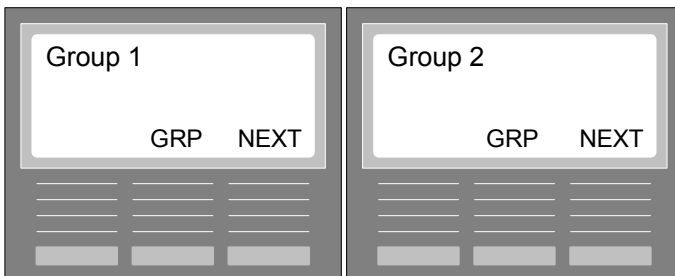

- 2 Pressing the **GRP** softkey toggles between **Group 1** and **Group 2**. To select the Group, press the **NEXT** softkey. The Date screen will display.

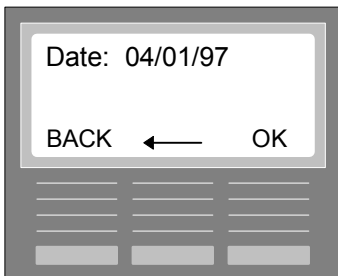

- 3 Press the **Left Arrow** softkey to scroll through the Dates where Routing changes have occurred. The first Date to display is the current Date when a Routing change (Routing Time Period) occurred. Pressing the Left Arrow displays the previous Date.

**Note:** A Routing change is when you enter the Routing Session (Feature 921) and enable Day or Night Routing and then return later to disable Day or Night Routing. This Routing change will be referred to as a Routing Time Period. 21 Routing Time Periods are tracked. There could be, for example, several Routing Time Periods in one Day (Date) or 1 Routing Time Period for several days. The Routing Time

Period lengths depend entirely on when you physically enable and disable Day or Night Routing in the Routing Session.

- When you have displayed the Date, press the **OK** softkey. The Time screen will display.



(Example 1)

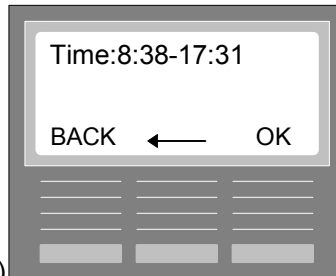

(Example 2)

**Notes and Examples:** The Time format is military (00:00-24:00). In Example 1, this time period is still current (XX:XX = current time) and falls within the 24 hour period for the current Date. The Day Routing was enable at 8:34 in the morning and has not been disabled at the current time. When a Routing Time Period occurs within the 24 hour Date period, a - (dash) symbol will display to separate the enabled time from the disabled time (08:38-17:31 - Example 2).

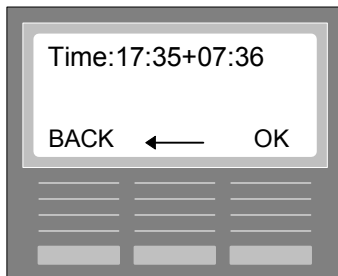

(Example 3)

In Example 3, this time for the Date selected starts at 17:35 in the evening but goes beyond the 24 hour period for the Date. When a Routing Time Period extends beyond the 24 hour Date period, the + (plus) symbol will display to separate the enabled time from the disabled time (17:35+07:36).

When a + symbol displays, it does not always mean that the Routing Time Period has extended only into the next day. The Routing Time Period could extend across several days, or even weeks, depending on when you enable and disable Day or Night Routing. As an example, the Date screen(04/01/97) displaying above has a time period of 17:35+7:36. This could mean that the 7:30 ending time could be for the next morning or any following morning. The only way you can calculate is to BACK up to the Date screen and scroll to the next Date. If the next Date for example, is 04/04/97, the Routing Time Period's length is from 17:35 (04/01/97) through 7:36 (04/04/97); that is 2 days and 14 hours worth of Call Data Statistics for 1 Routing Time Period.

- Use the **Left Arrow** softkey to scroll to the Time you want to select. When you have displayed this Routing Time Period, press the **OK** softkey. The first Statistics screen # ANSWERED will display.

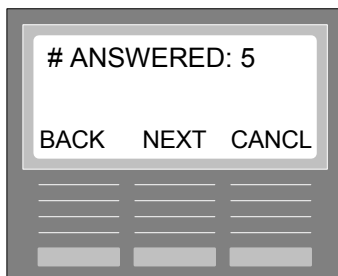

(Example)

**Number of ACD Calls Answered by Agents** for the selected Group, Date, and Routing Time Period

**Note:** Pressing BACK displays the previous Time screen. Pressing CANCL ends the viewing of statistics and returns you to the Group screen.

- To view the next Statistic, press the **NEXT** softkey.

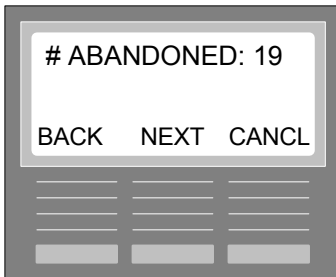

(Example)

**Number of ACD Calls Abandoned by Callers** for the selected Group, Date, and Routing Time Period

**Note:** Pressing **BACK** displays the previous Statistics screen. Pressing **CANCL** ends the viewing of statistics and returns you to the Group screen.

- 7 To view the next Statistic, press the **NEXT** softkey.

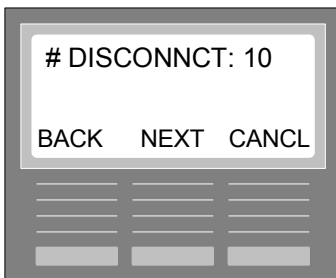

(Example)

**Number of ACD Calls Disconnected by the Disconnect Night Routing Command** for the selected Group, Date, and Routing Time Period

**Notes:** Pressing **BACK** displays the previous Statistics screen. Pressing **CANCL** ends the viewing of statistics and returns you to the Group screen.

If you have selected a Day Routing Time Period, the ACD Call numbers displaying for this Disconnect statistic will not be Disconnect statistics. Instead they will be "Calls Picked Up" events. Calls Picked Up is when ACD calls are answered on a Station Set other than the Station Set to which an ACD Call is distributed.

- 8 To view the next Statistic, press the **NEXT** softkey.

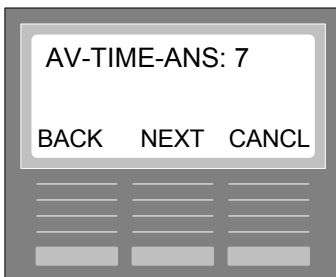

(Example, time in seconds)

**Average Time it took Agents to Answer ACD Calls** for the selected Group, Date, and Routing Time Period

**Note:** Pressing **BACK** displays the previous Statistics screen. Pressing **CANCL** ends the viewing of statistics and returns you to the Group screen.

- 9 To view the next Statistic, press the **NEXT** softkey.

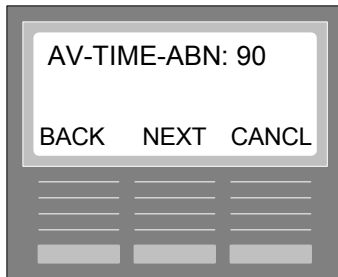

(Example, time in seconds)

**Average Time it took Callers to Abandon ACD Calls** for the selected Group, Date, and Routing Time Period

**Note:** Pressing **BACK** displays the previous Statistics screen. Pressing **CANCL** ends the viewing of statistics and returns you to the Group screen.

**10** To view the next Statistic, press the **NEXT** softkey.

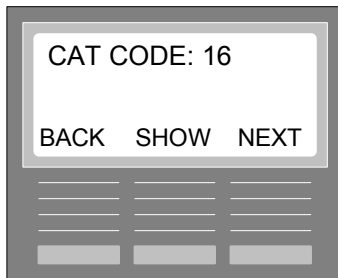

(Example)

**11** Type in up to **2 numeric characters for the Category Code** (10-30, 21 possible codes) on which you want to view statistics. Then press the **SHOW** softkey. The next screen to display:

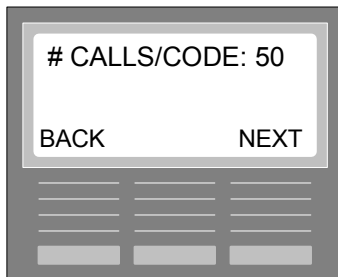

(Example)

**Number of ACD Calls Answered by Agents per Category Code** for the selected Group, Date, and Routing Time Period

**Note:** Pressing **BACK** displays the previous **CAT CODE** screen so you can enter another Category Code.

**12** Pressing the **NEXT** softkey displays the Group screen.

Notes:





# Chapter 13: Group Status Session

In this Chapter directions are provided to view the Calls Queued and Time in Queue Status for Group 1 and Group 2 by using a Feature Session.

► **Calls Queued**

Number of ACD Calls currently in queue waiting to be answered by Agents

► **Time In Queue**

The longest time in queue an ACD Call is currently in queue

This feature is designed so that anyone can easily and quickly see the Group Status. The Group Status Feature Code 923 can be programmed to a programmable button on the Station Set. In doing this, the Status for both Groups can be easily viewed by pressing one key. An Agent can view the same status by logging in and invoking the Calls Queued Function.

## Group Status Flow Chart

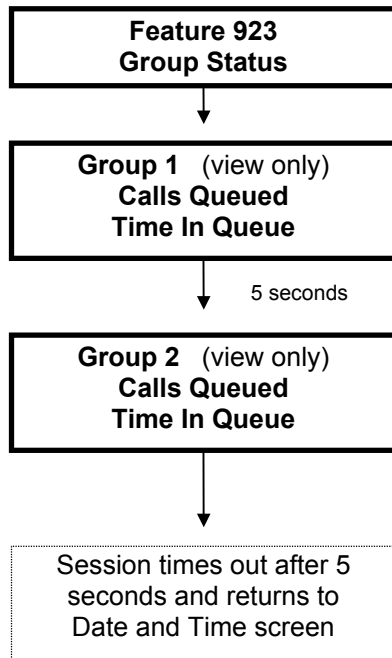

## Viewing Group Status

If the Group Status Session Feature Code (default 923) has been assigned by Norstar for a different feature, you can specify a different code.

Using either a **T7316**, **M7310**, **M7324**, **C3050**, or **3060 Station Set** follow these directions to view the Group Status for Group 1 and 2:

- 1 On the Station Set, press the **Feature** button and then press **923** on the dial pad for the Group Status Session Feature Code.



The Group 1 screen will display Calls Queued and Time In Queue for 5 seconds. Then Group 2 screen will display Calls Queued and Time In Queue for 5 seconds.

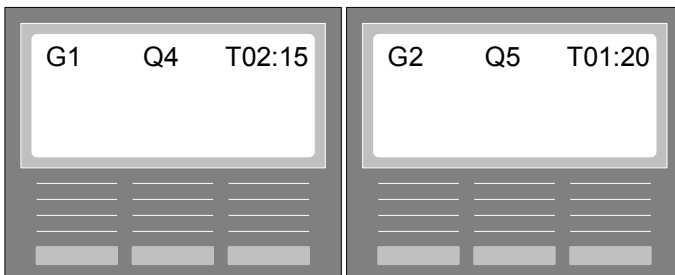

The Group Status Session will end and the Date and Time screen will display.

**Note:** If you are using a **C3050** or **C3060 Station Set**, you must press the **Terminate Activity** button after you use the **Group Status** feature to be able to receive calls.

## Group Status Session

---

Notes:



# Chapter 14: Performing Agent Functions

There are 2 sections in this Chapter:

- ▶ **Agent Functions**
- ▶ **Using Analog 2500 Sets**

## Agent Functions

There are 5 Agent Functions you can perform:

- ▶ **Login**  
The system is notified that an Agent is ready to receive ACD Calls.
- ▶ **Unavailable**  
The Agent is still logged in but is not receiving ACD Calls at this time.
- ▶ **Cancel Wrap**  
Enables the Agent to end the specified length of time needed to wrap up the last call and become available to receive an ACD Call.
- ▶ **Calls Queued**  
The Agent can display the number of calls in queue and the duration of the longest call in queue for each Group into which the Agent has logged.
- ▶ **Categorize**  
At the end of a call, the Agent enters a user defined tracking code (10-30) or category for each ACD Call. If Force Categorization is set to YES, then the Agent will be prompted to enter code after the call; if NO, then the Agent must remember to enter the code after the call (if a Category Code is desired) during wrap time.

You can use the **C3050** and **C3060** (Companion Sets) to perform Agent functions.

The **T7100** or **M7208** does not have Softkeys below the Single Line LCD. The following keypad keys replace the Softkeys: #, \*, and **Rls**.

**Notes:** Refer to the About MINUET Chapter for directions to view the list of Agent Function Feature Codes assigned by Norstar. You can program these Feature Codes on the programmable memory keys on the Norstar Station Sets.

All Functions performed in these sections will use the T7316 Station Set as the example.

### Login

**Note:** It is recommended that you program the Login Feature Code to a memory key and label that key with the Login key cap. Once programmed, the indicator light will display on the LCD beside the Login Key.

Follow these steps to Login an Agent:

- 1 Press the **Login Key**, or press the **Feature Key** and type in **Login Feature Code** (3 digits). The next screen to display:



- 2 Type in **Agent ID Number** (up to 4 digits).

**Note:** *BKSP (\* - T7100 / M7208) deletes characters right to left; EXIT (RIs - T7100 / M7208) aborts.*

- 3 Press the **OK Key** (or # - T7100 / M7208) to confirm and the Agent is ready to receive calls when the **Logged in** message displays. The next screen to display.

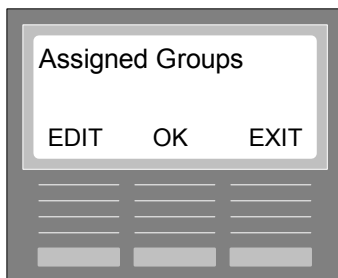

- 4 If you do not want to edit any Groups, press the **OK Key** (or # - T7100 / M7208) (Exit = RIs for T7100 / M7208). The Agent is ready to receive calls when the **Logged in** message displays.
- 5 However, if you want to change (edit) the Groups to which the Agent is assigned, press the **EDIT Key** (or \* - T7100 / M7208). The next screen to display:

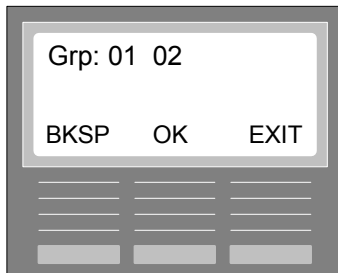

- 6 If you want to delete a Group, press the **BKSP Key** (or \* - T7100 / M7208) to delete from highest to lowest until you have deleted the specific Group. To add the Group back you did not want to delete, type in the Group Numbers (01 or 02 digits, in any order) (Exit = RIs for T7100 / M7208).  
**Note:** *Edits are only effective for the period you are logged in. If you log out and log back in for example, both Groups 01 and 02 will display.*
- 7 When you have completed viewing or editing, press the **OK Key** (or # - T7100 / M7208) to confirm. The **Logged in** screen will display for a few moments and then the Date and Time screen will display.



## Performing Agent Functions

---

**Note:** If you are using a **C3050** or **C3060** Station Set, you must press the **Terminate Activity** button after you **Login** to be able to receive calls.

### Login Errors:



- Invalid Agent ID Number.

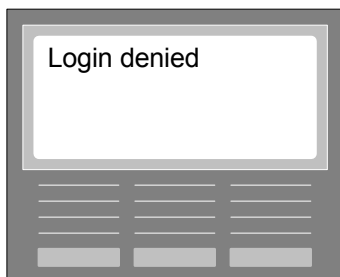

- ▶ ID already logged in.
- ▶ Agent tried to login on the Backup Station Set.



- ▶ Agent tried to perform an Agent function without logging in.



- ▶ Agent stopped login or was timed out (15 seconds).
- ▶ Agent ID has not been assigned to any Group(s).



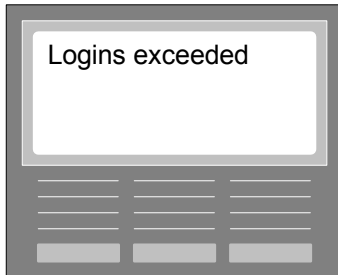

- ▶ Agent tries to login when system has reached capacity for Agent logins.

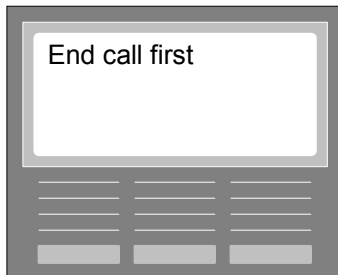

- ▶ Agent tried to logout while on an ACD Call.

### **Receiving Calls**

When a call is sent to the Agent's Station Set, the abbreviated Group Name displays (up to 8 digits) and the length of time the call has been in the queue.



#### **To accept the call:**

- ▶ Handset - pick up receiver.
- ▶ Headset - press flashing Intercom Key or Handsfree Mute key. If Answer Forcing is set to YES, you will receive a zip tone and then the call.

### **Overflow Call**

If an overflow call is being sent to you from another Group, the name of the Group from which the call originated displays with a + symbol followed by the length of time the call has been in the queue.

# Performing Agent Functions

---



## Log Out

**Note:** Agent will automatically be logged out after 3 rings or 15 seconds; therefore, if Agent does not want to be automatically logged out, they should go unavailable. Refer to Available/Unavailable.

Follow the same steps used for Log In and follow the display screens.

- 1 Press the **Login Key**, or press the **Feature Key** and type in the **Login Feature Code**.

The next screen to display:

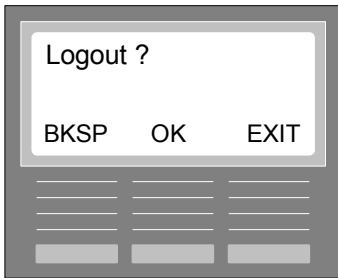

- 2 Press the **OK Key** (or # - T7100 / M7208) to Logout (BKSP = \* and EXIT = Rls for T7100 / M7208). A "Logged out" message will display for a few moments before the Date and Time screen displays.

### Error Messages:



- ▶ Agent stopped logout by pressing the EXIT key, or the Rls button, or was timed out (15 seconds).

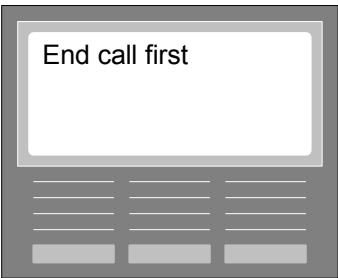

- ▶ Agent tried to logout when on a call.

## Unavailable/Available

**Notes:** If an Agent is available but does not take an ACD Call within 3 rings (15 seconds), the Agent will automatically be logged out. Therefore, if the Agent is not going to be able to take an ACD Call for any reason, the Agent should go Unavailable.

It is recommended that you program the Unavailable Feature Code to a memory key and label that key with the Unavailable key cap. Once programmed, the indicator light will display on the LCD beside the Unavailable Key.

Follow this step to make an Agent Unavailable to receive calls:

- 1 Press the **Unavailable Key**, or press the **Feature Key** and type in the **Unavailable Feature Code** (3 digits). The next screen to display for 5 seconds:



The next screen to display is Date and Time. The Indicator arrow for Unavailable Key displays if it was programmed.

**Note:** An Agent cannot go Unavailable when a Station Set is ringing.

Repeat the same step to become **Available**. An Available message will display for a few moments before the Date and Time screen displays. The Indicator arrow for the Unavailable Key is extinguished if it was programmed.

**Note:** If you try to go Unavailable during a call, the call will not be affected. After the call, you will be Unavailable. If Wrap Duration is set, this period will become effective as soon as you go Available. You will not receive a call until the wrap duration ends, or you Cancel Wrap.

**Note:** If you are using a **C3050** or **C3060** Station Set, you must press the **Terminate Activity** button after you become **Available** to be able to receive calls.

### Error Message:



- ▶ Agent tried to perform a function without logging in.

### Cancel Wrap

Follow this step to Cancel Wrap Duration and free Station Set for next call:

- 1 Press the **Cancel Wrap Key**, or press the **Feature Key** and type in the **Cancel Wrap Feature Code**. The Date and Time screen reappears. The Agent is ready to receive the next call.

*Note: If you are using a C3050 or C3060 Station Set, you must press the **Terminate Activity** button after you use **Cancel Wrap** to be able to receive calls.*

#### Error Messages:



- ▶ Agent is in wrap and unavailable but tries to cancel wrap before going available.



- ▶ Agent tried to perform a function without logging in.

### Categorize

Follow these steps to enter a **Category Code** after the call has been completed:

- 1 If Force Categorization has been set to YES, you will be prompted by the following screen after releasing the call while in wrap:



If Force Categorization has been set to NO and you want to enter a Category Code, press the **Categorize Key**, or press the **Feature Key** and type in the **Categorize Feature Code** (3 digits). The same screen as above will display.

- 2 Type in the **Category Code(s)** (2 digits, range - 10-30) and press the **OK Key** (or # - T7100 / M7208) (BKSP = \* and EXIT = Rls for T7100 / M7208).

**Note:** Administration Statistics are only tracked for code numbers 10 through 30 (21 possible codes).

**Note:** If you are using a C3050 or C3060 Station Set, you must press the **Terminate Activity** button after you use the **Categorize** feature to be able to receive calls.

## Calls Queued

**Note:** An Agent can use this feature while on or off a call to see how many calls are in queue and which call has the longest duration in queue. Only the Groups in which the Agent has logged in can be viewed by Agent.

Follow these steps to view the Calls Queued:

- 1 Press the **Calls Queued Key**, or press the **Feature Key** and type in the **Calls Queued Feature Code**.
- 2 If you are on a call and you press the **Calls Queued Key**, you will receive the status for calls in your current Group. Each time you press the Call Queued Key, you will receive the status for the next Group into which you are logged.

For example, you are logged in to Group 1 and 2. You are on a call for Group 1, there are 4 calls in queue, and one of the calls has been in queue the longest for 2 minutes and 15 seconds. If you press the Calls Queued button, the LCD screen will display the following screen:

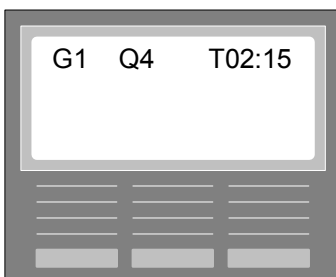

If you press the Calls Queued button again, Group 2 status will display. You can view both Groups by pressing the Calls Queued button.

If you are not on a call and you press the Calls Queued button, you will start at your first Group. In the example above, Group 1 status would display first; and, each time you pressed the button, the next Group status would display.

G# = Group Number

Q# = Number of calls in queue

TMM:SS = time of longest call in queue

**Note:** If you are using a C3050 or C3060 Station Set, you must press the **Terminate Activity** button after you use the **Calls Queued** feature to be able to receive calls.

### Error Message:



- ▶ Agent tried to perform a function without logging in.

## Using Analog 2500 Sets

An Agent can use these Sets with MINUET ACD to receive ACD Calls and perform the following Agent functions:

- ▶ Login
- ▶ Logout
- ▶ Available
- ▶ Unavailable

**Note:** *These are the only functions an Agent can perform using the Analog Sets.*

To start, a **Login/Logout DN** and an **Available/Unavailable DN** must be specified. Refer to the System Admin Chapter for directions to specify these DNs.

Once the DNs are specified, they can be programmed to a button on the Analog Set. Refer to the Analog Set manual.

### Login/Logout

Follow these steps to Login and Logout an Agent using an Analog Set:

#### Login

- 1 Pick up the handset, enter the **Login/Logout DN**, enter your **Agent ID**, and press the **#** key. You are logged in and are Available to receive ACD calls.

If the Login is successful, you will hear **2 sets of 2 beeps each rising in pitch**.

If Login fails because a wrong Login/Logout DN was entered, MINUET ACD will ignore the request and the Norstar will give you a busy signal. Restart Login.

If Login fails because a wrong Agent ID or Password was entered, you will hear **1 long beep**. Restart Login.

#### Logout

- 1 Enter the same **Login/Logout DN** and press the **#** key. You will hear **2 sets of 2 beeps each falling in pitch**.

If the wrong Login/Logout DN is entered, you will hear **1 long beep**. Try Logout again.

### Available/Unavailable

Follow these steps to go Unavailable and then Available while you are logged in:

#### Unavailable

- 1 Enter the **Available/Unavailable DN**.

If the wrong Available/Unavailable DN is entered, MINUET ACD will ignore the request and the Norstar will give you a busy signal. Try again to go Unavailable.

### **Available**

- 1 While Unavailable, enter the **Available/Unavailable DN**.

If the wrong Available/Unavailable DN is entered, MINUET ACD will ignore the request and the Norstar will give you a busy signal. Try again to go Available.

**Note:** *If an Agent's Group is using Wrap, an Agent using an Analog Set will receive the same Wrap duration period. When Wrap Duration has ended, the Agent will be available to receive a call. An Agent can cancel Wrap by going Unavailable and then back to Available during the Wrap period.*

*Refer to your Analog Set manual and/or the ATA manual for directions to use the Set's features. The features covered in this guide only pertain when using an Analog Station Set with MINUET ACD.*

# Appendices

## Appendix 1: Error Messages

The following Error Messages occur when you have entered an incorrect entry. Following each Error Message there is a brief explanation of the error.



- ▶ The user tried to configure more than the maximum of 20 Agents.



- ▶ The user entered an Agent ID to be deleted that did not exist.



- ▶ The user tried to delete the last configured Agent. At least 1 Agent must remain configured.



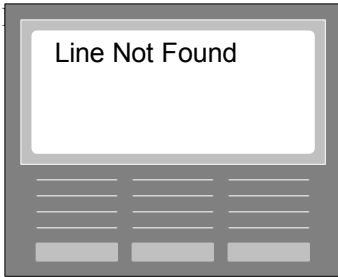

- ▶ The user entered a Line Number that did not exist.

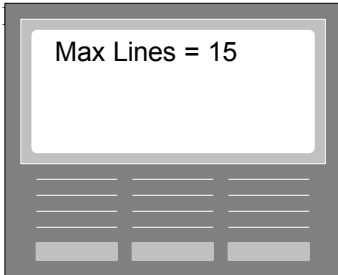

- ▶ The user tried to configure more than the maximum of 15 Lines.



- ▶ The user tried to view (show) a Line; however, no lines had been configured.



- ▶ The user entered the incorrect number of characters for an Agent ID.

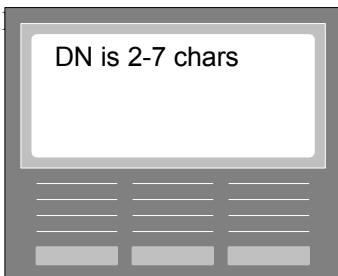

- ▶ The user entered the incorrect number of characters for a Directory Number.

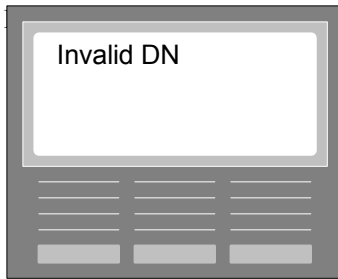

- ▶ The user entered a Directory Number already in use or non-existent



- ▶ The user entered a Voice Mail Mail Box Number already in use or non-existent.

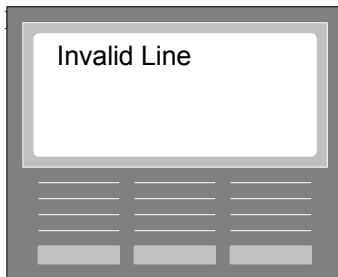

- ▶ The User entered a Line number that was not configured as an ACD line.



- ▶ The user entered a Feature Code already in use or non-existent.



- ▶ The user entered a Login Directory Number already in use.



- ▶ The user entered a Directory Number already in use.

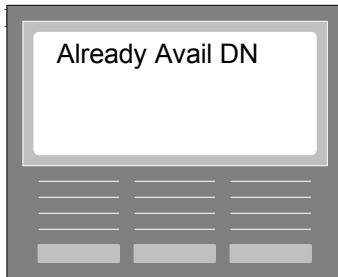

- ▶ The user entered an Available Directory Number already in use.



- ▶ The user entered a Directory Number already in use.



- ▶ The user entered a Directory Number already in use.

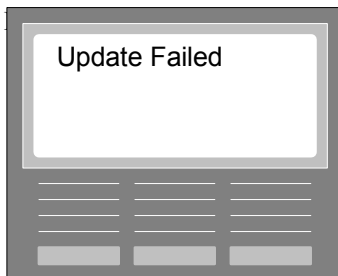

- ▶ A Configuration Update cannot be completed at this time. Try again later.



- ▶ A backup Station Set DN must be entered before using MINUET ACD.

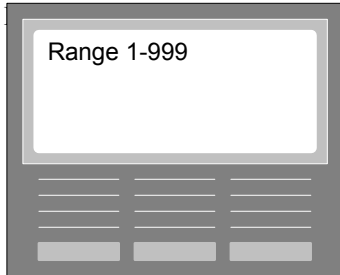

- ▶ The User entered a number(s) (in seconds) out of the range for the Distribute command.



- ▶ The User entered alphanumeric characters rather than numeric.

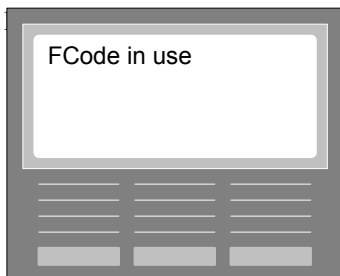

- ▶ The User tried to change a Session Feature Code to a code that was being used by another application.

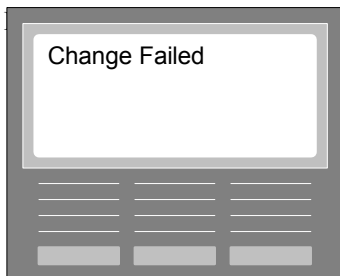

- ▶ The User tried to change a Session Feature Code to a code but a Feature Code Table was already in use. Try again later.

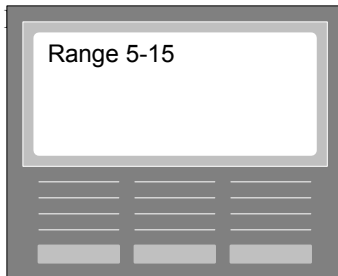

- ▶ The User tried to specify an ICLID Delay time period out of the specified range Of 5-15 seconds.

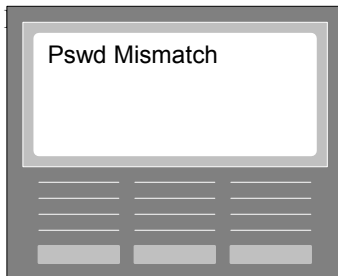

- ▶ The User entered a Verify Password that was not the same as the New Password.

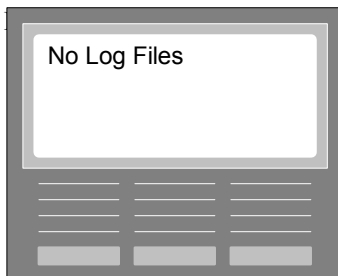

- ▶ There are no Log Files to copy or delete; Logging was not turned ON and then turned OFF.



- ▶ The disk to where Log Files were to be copied is not functioning properly.



- ▶ During the process of deleting Log Files, the system encountered a File that was still opened.
- ▶ During the process of copying Log Files to a disk, the system encountered a File that could not be accessed.



- ▶ During the process of copying Log Files to a disk, the system encountered a File that was accessible but still couldn't be copied.

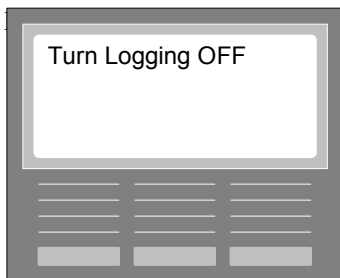

- ▶ A User tried to copy Log Files or delete Log Files before turning Logging OFF.



- ▶ The ICLID Delay time period set in Line Administration cannot be greater than the DELAY ANSWER Routing Command time period set in Group Administration.



- ▶ In Group Administration, the Group Name field must be completed before the Group can be configured.

## Appendix 2: Configuration Worksheets

### Group Administration

(Photocopy As Required)

Group 1	Group 2
<b>Name:</b>                 (8 alphanumeric)	<b>Name:</b>                 (8 alphanumeric)
<b>Transfer DN:</b>         (3-4 numeric)	<b>Transfer DN:</b>         (3-4 numeric)
<b>Wrap Duration:</b>       seconds (up to 2 numeric)	<b>Wrap Duration:</b>       seconds (up to 2 numeric)
<b>Agent Selection:</b> Longest Idle (or) Top Down	<b>Agent Selection:</b> Longest Idle (or) Top Down
<b>Prompted Categorization:</b> Yes No	<b>Prompted Categorization:</b> Yes No
<b>Overflow Calls:</b>       (up to 2 numeric)	<b>Overflow Calls:</b>       (up to 2 numeric)
<b>Day Routing Commands:</b> Step 1: Delay Answer       seconds (up to 3 numeric) Step 2: Announcement 1 (or) Step 2: Forced Announcement 1 Step 3: Distribute       seconds (up to 3 numeric) (1-999) Step 4: Wait Announcement 2 Step 5: Distribute       seconds (up to 3 numeric) (1-999) Step 6: Go To Step 4 (or) Step 6: Voice Mail Transfer         (2 to 4 numeric) (or) Step 6: Transfer To DN         (2 to 4 numeric) (or) Step 6: Group: 2	<b>Day Routing Commands:</b> Step 1: Delay Answer       seconds (up to 3 numeric) Step 2: Announcement 4 (or) Step 2: Forced Announcement 4 Step 3: Distribute       seconds (up to 3 numeric) (1-999) Step 4: Wait Announcement 5 Step 5: Distribute       seconds (up to 3 numeric) (1-999) Step 6: Go To Step 4 (or) Step 6: Voice Mail Transfer         (2 to 4 numeric) (or) Step 6: Transfer To DN         (2 to 4 numeric) (or) Step 6: Group: 1
<b>Night Routing Commands:</b>	<b>Night Routing Commands:</b>



Group 1	Group 2
Step 1: Nite Announcement 3 (or)	Step 1: Nite Announcement 6 (or)
Step 1: No Answer	Step 1: No Answer
Step 2: Disconnect (or)	Step 2: Disconnect (or)
Step 2: Voice Mail Transfer         (2 to 4 numeric)	Step 2: Voice Mail Transfer         (2 to 4 numeric)

### Agent Administration

(Photocopy As Required)

(20 Agents maximum)

Longest Idle Agents	Longest Idle Agents
<b>Agent ID:</b>         (2 to 4 numeric)	<b>Agent ID:</b>         (2 to 4 numeric)
<b>Answer Forcing:</b> Yes No	<b>Answer Forcing:</b> Yes No
<b>Assign to Group 1:</b> Yes No	<b>Assign to Group 1:</b> Yes No
<b>Assign to Group 2:</b> Yes No	<b>Assign to Group 2:</b> Yes No
<b>Agent ID:</b>         (2 to 4 numeric)	<b>Agent ID:</b>         (2 to 4 numeric)
<b>Answer Forcing:</b> Yes No	<b>Answer Forcing:</b> Yes No
<b>Assign to Group 1:</b> Yes No	<b>Assign to Group 1:</b> Yes No
<b>Assign to Group 2:</b> Yes No	<b>Assign to Group 2:</b> Yes No
<b>Agent ID:</b>         (2 to 4 numeric)	<b>Agent ID:</b>         (2 to 4 numeric)
<b>Answer Forcing:</b> Yes No	<b>Answer Forcing:</b> Yes No
<b>Assign to Group 1:</b> Yes No	<b>Assign to Group 1:</b> Yes No
<b>Assign to Group 2:</b> Yes No	<b>Assign to Group 2:</b> Yes No
<b>Agent ID:</b>         (2 to 4 numeric)	<b>Agent ID:</b>         (2 to 4 numeric)
<b>Answer Forcing:</b> Yes No	<b>Answer Forcing:</b> Yes No
<b>Assign to Group 1:</b> Yes No	<b>Assign to Group 1:</b> Yes No
<b>Assign to Group 2:</b> Yes No	<b>Assign to Group 2:</b> Yes No
<b>Agent ID:</b>         (2 to 4 numeric)	<b>Agent ID:</b>         (2 to 4 numeric)
<b>Answer Forcing:</b> Yes No	<b>Answer Forcing:</b> Yes No
<b>Assign to Group 1:</b> Yes No	<b>Assign to Group 1:</b> Yes No

# Appendices

---

Longest Idle Agents	Longest Idle Agents
Assign to Group 2: Yes      No	Assign to Group 2: Yes      No

## Agent Administration

(Photocopy As Required)

(20 Agents maximum)

Top Down Agents	Top Down Agents
Agent ID:           (2 to 4 numeric)	Agent ID:           (2 to 4 numeric)
Answer Forcing: Yes      No	Answer Forcing: Yes      No
Assign to Group 1: Yes      No	Assign to Group 1: Yes      No
Assign to Group 2: Yes      No	Assign to Group 2: Yes      No
Group 1 Position ____ Group 2 Position ____	Group 1 Position ____ Group 2 Position ____
Agent ID:           (2 to 4 numeric)	Agent ID:           (2 to 4 numeric)
Answer Forcing: Yes      No	Answer Forcing: Yes      No
Assign to Group 1: Yes      No	Assign to Group 1: Yes      No
Assign to Group 2: Yes      No	Assign to Group 2: Yes      No
Group 1 Position ____ Group 2 Position ____	Group 1 Position ____ Group 2 Position ____
Agent ID:           (2 to 4 numeric)	Agent ID:           (2 to 4 numeric)
Answer Forcing: Yes      No	Answer Forcing: Yes      No
Assign to Group 1: Yes      No	Assign to Group 1: Yes      No
Assign to Group 2: Yes      No	Assign to Group 2: Yes      No
Group 1 Position ____ Group 2 Position ____	Group 1 Position ____ Group 2 Position ____
Agent ID:           (2 to 4 numeric)	Agent ID:           (2 to 4 numeric)
Answer Forcing: Yes      No	Answer Forcing: Yes      No
Assign to Group 1: Yes      No	Assign to Group 1: Yes      No

Top Down Agents	Top Down Agents
Assign to Group 2: Yes No	Assign to Group 2: Yes No
Group 1 Position ____ Group 2 Position ____	Group 1 Position ____ Group 2 Position ____
Agent ID:         (2 to 4 numeric)	Agent ID:         (2 to 4 numeric)
Answer Forcing: Yes No	Answer Forcing: Yes No
Assign to Group 1: Yes No	Assign to Group 1: Yes No
Assign to Group 2: Yes No	Assign to Group 2: Yes No
Group 1 Position ____ Group 2 Position ____	Group 1 Position ____ Group 2 Position ____

**Line or PRI/DNIS/DID Administration**

(Photocopy As Required)

Lines (15 maximum) or PRI (2 maximum)	Lines (15 Maximum) or PRI (2 maximum)
Line Number or PRI:       (3 numeric)	Line Number or PRI:       (3 numeric)
Assign to Group 1: (or) Group 2:	Assign to Group 1: (or) Group 2:
ICLID Delay: Yes No	ICLID Delay: Yes No
Line Number:       (3 numeric)	Line Number:       (3 numeric)
Assign to Group 1: (or) Group 2:	Assign to Group 1: (or) Group 2:
ICLID Delay: Yes No	ICLID Delay: Yes No
Line Number:       (3 numeric)	Line Number:       (3 numeric)
Assign to Group 1: (or) Group 2:	Assign to Group 1: (or) Group 2:
ICLID Delay: Yes No	ICLID Delay: Yes No
Line Number:       (3 numeric)	Line Number:       (3 numeric)
Assign to Group 1: (or) Group 2:	Assign to Group 1: (or) Group 2:
ICLID Delay: Yes No	ICLID Delay: Yes No
Line Number:       (3 numeric)	Line Number:       (3 numeric)
Assign to Group 1: (or) Group 2:	Assign to Group 1: (or) Group 2:
ICLID Delay: Yes No	ICLID Delay: Yes No
Line Number:       (3 numeric)	Line Number:       (3 numeric)
Assign to Group 1: (or) Group 2:	Assign to Group 1: (or) Group 2:
ICLID Delay: Yes No	ICLID Delay: Yes No

## Appendices

Lines (15 maximum) or PRI (2 maximum)	Lines (15 Maximum) or PRI (2 maximum)
Line Number:         (3 numeric)	Line Number:         (3 numeric)
Assign to Group 1: (or) Group 2:	Assign to Group 1: (or) Group 2:
ICLID Delay: Yes No	ICLID Delay: Yes No
Line Number:         (3 numeric)	
Assign to Group 1: (or) Group 2:	
ICLID Delay: Yes No	

### System Administration, Passwords, and Feature Codes

(Photocopy As Required)

System Parameters	Passwords and Session Feature Codes
Backup Station Set DN:         (3 to 4 numeric)	<b>Administration Session - Feature 920</b>                             (up to 12 numeric)
ICLID Delay Time Period:       seconds (5-15)	<b>Routing Session - Feature 921</b>                             (up to 12 numeric)
Options: None (or) Wallboard (select COM Port)	<b>Administration Maintenance Session - Feature 9*7</b>                             (up to 12 numeric)
Logout/Login DN:           (3 to 4 numeric)	<b>Administration Session Feature Code - 920</b> Changed to:
Unavail/Avail DN:           (3 to 4 numeric)	<b>Routing Session Feature Code - 921</b> Changed to:
	<b>Administration Maintenance Session Feature Code - 922</b> Changed to:
	<b>Group Status Session Feature Code - 923</b> Changed to:

## Appendix 3: Norstar Non-physical Directory Number

MINUET ACD is designed to utilize 3 Norstar DNs for the following functions:

- ▶ Transfer (Xfr) DN for Group 1 and/or Group 2 allowing incoming calls to be transferred into the ACD Group queue.
- ▶ Login DN for 2500 Analog Set
- ▶ Unavailable DN for 2500 Analog Set

### Rules and important information:

- ▶ The Directory Number must not be in use on the Norstar as a Station Set or other device. It must be higher than the highest possible DN.
- ▶ The easiest way to find a valid DN is to dial an intercom number that is higher than the current extension numbers (301 is usually a good choice for a DN on most Norstar systems). If the Norstar response is “Not In Service” that DN should work as a DN. If the Norstar response is “Invalid DN” that DN will not work as a DN because it is probably too high.
- ▶ It is best to keep the selection logical for a Xfr DN (e.g., 301 for Group 1 and 302 for Group 2).
- ▶ The only way to test a DN is to make an incoming call to a Station Set then BLIND transfer that incoming call directly to the DN. The DN cannot be called as an intercom call. Once configured in the ACD, it will just ring open and will not answer.
- ▶ A DN can be programmed on a Station Set as an internal autodial.

## Appendix 4: MIN / MAX Reference

### Purpose

The purpose of this reference is to explain how to set the MIN and MAX values for voice channels intended to be used for Norstar Voice Mail 3.0 and MINUET ACD.

### Voice Channels

Every MINUET installation has the capability to use a maximum of 4 voice channels. “Channel Activations” cannot and need not be purchased for MINUET.

### Voice Channels: Shared or Dedicated

Voice Channels for MINUET can be configured as shared or dedicated. A “shared” voice channel can be used either by MINUET or Voice Mail as needed to accommodate the available application. A “dedicated” voice channel is exclusively used by either MINUET or Voice Mail.

## Appendices

MINUET and Norstar Voice Mail are ACCESS applications. For each ACCESS application, there are defined voice channel variables called MIN (minimum) and MAX (maximum).

- ▶ **MIN value** - the number of dedicated channels needed for the application.
- ▶ **MAX value** - the maximum number of channels (shared and dedicated) that the application can use.
- ▶ **MAX (minus) MIN** = the number of shared channels for an application.

Before you install MINUET, you need to know the number of physical voice channels available on the Applications Module and how many of these channels are being used by Voice Mail. You will then be able to decide how many channels MINUET will have to share with Voice Mail and/or how many channels can be dedicated to MINUET.

### Example Voice Channel Combinations for Norstar Voice Mail 3.0 and MINUET ACD

The following example table lists several combinations of Voice Mail voice channels and MINUET voice channels that can be configured under the following assumptions:

- ▶ As the customer has purchased a number of Authorized Voice Mail Voice Channels, the table assumes that Voice Mail should be able to use all of these channels. No configurations are shown in which the number of Voice Mail channels is reduced.
- ▶ The configurations shown in the table attempt to maximize the use of available voice channels. Configurations that share channels but leave other channels unused are not included as this would not be a realistic configuration.
- ▶ As Authorized Voice Mail Voice Channels are sold only in groups of 2, combinations of even numbers of channels are used.

The addition of a third voice channel application, such as an IVR, would make these tables considerably more complicated but the same configuration method would be used.

#### Examples 1-5: MS-BIC with 8 physical voice channels

#### Example 6: MS-BIC and an MS-PEC - total of 16 physical voice channels

Examples	Authorized VM Channels	MINUET Channels	VM-MIN (Dedicated)	VM-MAX	Shared Channels	MINUET-MIN (Dedicated)	MINUET-MAX
Example 1	4	4	4	4	0	4	4
Example 2	6	2	6	6	0	2	2
Example 3	6	4	4	6	2	2	4
Example 4	8	2	6	8	2	0	2
Example 5	8	4	4	8	4	0	4
Example 6	8	4	8	8	0	4	4

#### Example 1:

- ABC Company currently uses a 4-channel Voice Mail 3.0
- ABC Company wants to add MINUET ACD and allow it to use 4 channels
- Voice Mail uses 4 channels and MINUET uses 4 channels. In this scenario both applications can have 4 dedicated channels and voice channel sharing is not necessary.

**Voice Mail (NVM) MIN** is set to **4** and **MAX** is set to **4**

**MINUET (ACDVOICE) MIN** is set to **4** and **MAX** is set to **4**

Shared = 0

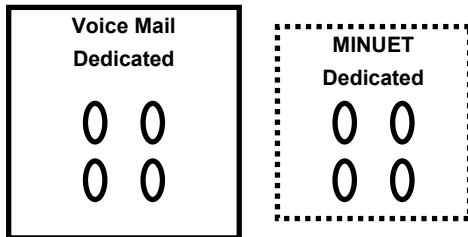

**Example 2:**

- CBA Company currently uses a 6-channel Voice Mail 3.0 and wants these channels dedicated to Voice Mail.
- CBA Company wants to add MINUET ACD and allow it to use 2 channels
- Voice Mail uses 6 channels and MINUET uses 2 channels. In this scenario both applications can have dedicated channels (Voice Mail has 6 and MINUET has 2) and voice channel sharing is not necessary.

**Voice Mail (NVM) MIN** is set to **6** and **MAX** is set to **6**

**MINUET (ACDVOICE) MIN** is set to **2** and **MAX** is set to **2**

Shared = 0

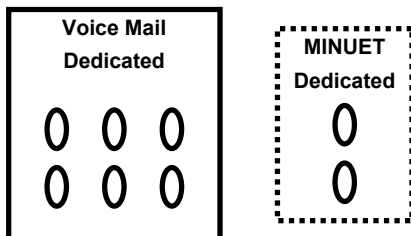

**Example 3:**

- XYZ Company currently uses a 6-channel Voice Mail 3.0
- XYZ Company wants to add MINUET ACD and allow it to use 4 channels
- Voice Mail uses 6 channels and MINUET uses 4 channels. In this scenario both applications can have dedicated channels (Voice Mail has 4 and MINUET has 2); however, both applications must share 2 voice channels.

**Voice Mail MIN** is set to **4** and **MAX** is set to **6**

**MINUET MIN** is set to **2** and **MAX** is set to **4**

Shared = 2

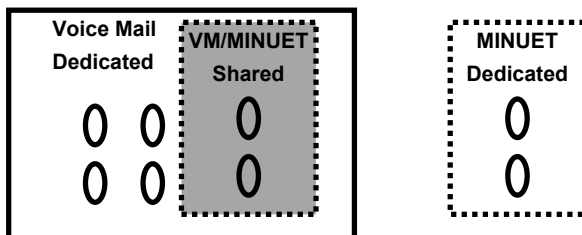

### Example 4:

- XYZ Company currently uses a 8-channel Voice Mail 3.0 and wants to dedicate 6 voice channels to Voice Mail
- XYZ Company wants to add MINUET ACD and allow it to use 2 channels
- Voice Mail uses 8 channels and MINUET uses 2 channels. In this scenario Voice Mail can have 6 dedicated channels; however, it must share the remaining 2 voice channels with MINUET.

**Voice Mail (NVM) MIN** is set to **6** and **MAX** is set to **8**

**MINUET (ACDVOICE) MIN** is set to **0** and **MAX** is set to **2**

**Shared = 2**

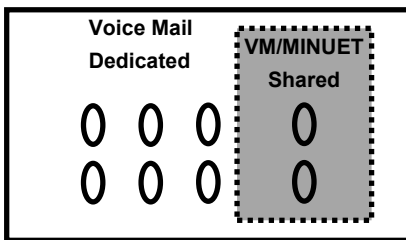

### Example 5:

- ZYX Company currently uses a 8-channel Voice Mail 3.0 and wants to dedicate 4 voice channels to Voice Mail
- ZYX Company wants to add MINUET ACD and allow it to use 4 channels
- Voice Mail uses 8 channels and MINUET uses 4 channels. In this scenario Voice Mail can have 4 dedicated channels; however, it must share the remaining 4 voice channels with MINUET.

**Voice Mail (NVM) MIN** is set to **4** and **MAX** is set to **8**

**MINUET (ACDVOICE) MIN** is set to **4** and **MAX** is set to **4**

**Shared = 4**

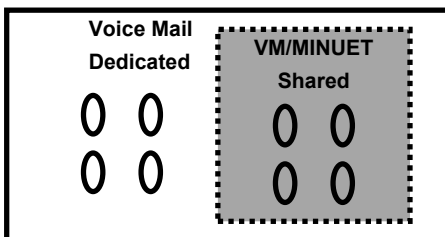



**Example 6:**

- AZ Company currently uses a 8-channel Voice Mail 3.0 and wants to dedicate 8 voice channels to Voice Mail
- AZ Company wants to add MINUET ACD and allow it to use 4 channels
- AZ Company must purchase an MS-PEC to add 8 more voice channels to the system
- Voice Mail uses 8 channels and MINUET uses 4 channels. In this scenario Voice Mail can have 8 dedicated channels and MINUET can have 4 dedicated channels. There will be 4 voice channels left unused in this scenario.

**Voice Mail MIN** is set to **4** and **MAX** is set to **8**

**MINUET MIN** is set to **0** and **MAX** is set to **4**

**Shared = 0**

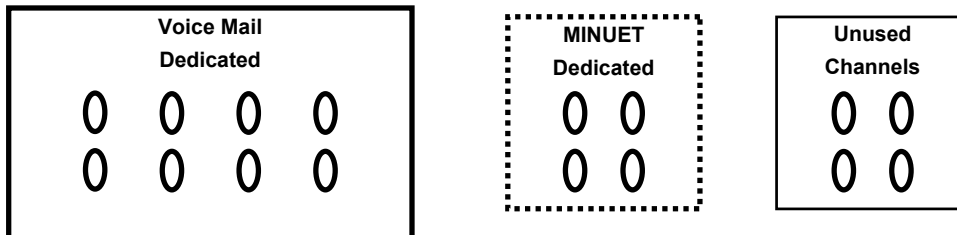

With the addition of 1 or more MS-PEC(s), the same method of configuring the MIN and MAX for applications still applies. Hopefully, the examples provided will help you configure these settings regardless of the number of installed voice channels.

## Appendices

---

Notes:

# Index

- (*dash*) symbol, 129

## #

# **ABANDONED**, 126  
 # **ANSWERED**, 126  
 # **CALL/CODE**, 126  
 # **DISCONNECT**, 126

## +

+ (*plus*) symbol, 129

## A

**About ACD**, 8, 28, 37  
**Access/2 Server**, 19, 21, 22, 23  
*ACD Call statistics*, 106  
**ACD Installing**, 21  
 ACD Lines, 85  
**ACD Started**, 21  
**ACD Updating**, 21, 23  
 ACD Version, 8, 31  
**ACD Version currently in use**, 26  
**Add a Line**, 70  
 Adding a Line, 76  
 Adding a Longest Idle Agent, 59  
 Adding a PRI, 78  
 Adding a Top Down Agent, 61  
**Adding Longest Idle Agent**, 56  
**Adding Top Down Agent**, 56  
**Admin**, 19, 21, 23  
 Admin Password, 96  
**Administration Maintenance Session**, 8, 94, 121  
 Administration Maintenance Session Feature Code, 110  
 Administration Maintenance Session Password, 8, 122  
 Administration Maintenance Session Password screen, 110  
 Administration Program Password, 19, 21, 22  
**Administration Session**, 8  
 Administration Session (Feature 930), 52, 81, 91  
 Administration Session Feature Code, 27, 114, 115, 116, 117

# Index

---

Administration Session Password, 8, 27, 94  
**Administration Statistics Session**, 8, 106  
Administration Statistics Session Feature Code, 128  
**Agent Admin** screen, 58, 60, 65  
Agent Administration, 52, 56, 67, 81, 91, 157, 158  
Agent Function Feature Codes, 27  
Agent Functions, 8, 138  
**Agent Functions Feature Codes**, 26  
Agent ID, 59, 61, 64, 65  
**Agent ID Number**, 139  
Agent ID screen, 61, 65, 66  
**Agent Name**, 64  
Agents, 8  
Analog 2500 Set, 89, 90  
ANNOUNCEMENT, 11, 43  
Announcement Maintenance, 8, 26, 45, 100  
Announcement Maintenance Feature Code, 29, 100  
Ans Forcing screen, 59, 61  
Appendices, 118  
Appendix 1: Error Messages, 148  
Appendix 2: Configuration Worksheets, 156, 161  
Application Directory, 19, 21, 23  
**Assign Agent to Group 1 and/or 2**, 56  
Assign Group 2 screen, 60, 62  
Assign Grp 1 screen, 60, 61  
**Assign Line to Group**, 70  
Automatic Call Distribution, 8  
Avail DN screen, 90  
Available DN (Directory Number), 90  
**Available.**, 143  
Available/Unavailable, 146  
**Available/Unavailable DN**, 146  
**Average Time Agents took to Answer ACD Calls for the selected Date and Routing Time Period**, 126  
**Average Time it took Agents to Answer ACD Calls**, 130  
**Average Time it took Callers to Abandon ACD Calls**, 131  
**Average Time it took Callers to Abandon ACD Calls for the selected Date and Routing Time Period**, 126  
Average Time To Abandon, 8  
Average Time To Answer, 8  
**AV-TIME-ABN**, 126  
**AV-TIME-ANS**, 126

## B

Backup Station Set, 85  
**Backup Station Set DN**, 84, 86  
Bakup DN, 86  
Bakup DN screen, 91

## C

*Call Data Statistics*, 129  
Calls Queued, 8, 26, 134, **138**, 145  
Calls Queued Feature Code, 29, 145  
**Calls Queued Key**, 145  
Cancel Wrap, 8, 26, **138**, 144

---

Cancel Wrap Duration, **144**  
Cancel Wrap Feature Code, 29, 144  
**Cancel Wrap Key**, 144  
**Categorize**, **138**, 144  
**Categorize Feature Code**, **144**  
**Categorize Key**, 144  
*Category Code*, 41, **144**  
Cfg FCode screen, 110, 115, 116, 117, 123  
**Change Administration (Cfg) Feature Code (default 930)**, 108  
**Change Administration Maintenance Password**, 8  
**Change Administration Maintenance Session (9\*7) Password**, 108  
**Change Administration Session (Configuration) Feature Code (Feature 930)**, 8  
**Change Administration Statistics Session Feature Code (Feature 932)**, 8  
**Change Administration Statistics Feature Code (default 932)**, 108  
**Change Password** screen, 96, 121, 123  
Change Passwords screen, 122  
**Change Routing Feature Code (default 931)**, 108  
**Change Routing Feature Code (Feature 931)**, 8  
Changing Administration Maintenance Session Password (Feature 9\*7), 122  
Changing Administration Session (Cfg) Feature Code, 114  
Changing Administration Session Password, 95  
Changing Administration Statistics Session Feature Code, 116  
Changing Group Status Session Feature Code, 117  
Changing Passwords, 105  
Changing Routing Session Feature Code, 115  
Changing Routing Session Password, 98  
Checks Group Overflow Table, 11  
Checks Routing Table, 10  
Cintech ACD Capacities and Features, 9  
*Cintech Customer Service*, 31  
*Cintech Customer Service 800-944-3901*, 123  
COM1 (Serial) Port, 24  
**Configuration**, 8  
Configuration Worksheets, 118  
Configuring a Group, 37  
Configuring a Line, 72  
Configuring an Agent, 58  
**Copying ACD**, 21, 23  
**Copying Startup**, 21, 23

**D**

Date, 128  
Date and Time screen, 135  
*Date screen*, 129  
*Day Routing*, 43, 105  
Day Routing Command Table, 11  
DELAY ANSR screen, 44  
DELAY ANSWER, 11, 43  
Delay Answer time period, 44  
Delete Agent screen, 66  
Delete Line screen, 77, 80  
**Deleting**, 56, 70  
**Deleting a Line**, 70, 76, 80  
**Deleting an Agent**, 56, 65

# Index

---

Directory Number, 85  
Directs Call to a Group, 10  
Disable/Enable Force Categorization, 41  
DISCONNECT, 11, 49  
DISCONNECT Command, 50  
DISCONNECT screen, 50  
**Displaying the Agent to Delete**, 56  
**Displaying the Line to Delete**, 70  
DISTRIBUTE, 11, 43  
DISTRIBUTE screen, 45  
Distribute time period, 45, 46  
Distributes Call to Agent, 11

## E

**EDIT an Agent**, 56  
EDIT an existing Line, 75  
**EDIT Line**, 70  
Enable Day or Night Routing, 105  
**Enable Option**, 84, 88  
**Enable/Disable Answer Forcing**, 56  
**Enable/Disable ICLID Delay**, 70  
**Error Message**, 143, 145  
**Error Messages**, 142, 144  
Executes Routing Commands, 11

## F

**Feature Code**, 114  
Features Codes screen, 28  
Force Categorization, 40, **144**  
FORCED ANNOUNCEMENT, 11, 43  
FORCED ANNOUNCEMENT (Night), 11

## G

G#, 145  
GO TO STEP, 11  
**GO TO STEP 3**, 43  
GROUP, 11, 43  
Group 1 screen, 128  
Group 2 Pos screen, 62  
Group Admin, 50  
Group Admin screen, 38  
Group Administration, 37, 52, 67, 81, 91, 156  
*Group Name*, 38  
GROUP screen, 48  
Group selection screen, 37  
**Group Status Session**, 8, 135  
Group Status Session Feature Code, 135  
Group: Group 1 screen, 74, 78  
Groups, 8

## H

**H. Appl Install**, 19, 21, 23

Handset, **141**  
hardware components, 24  
Headset, **141**

## I

ICLID Delay, 87  
ICLID Delay screen, 74, 79, 87  
*ICLID Delay time period*, 75, 85, 87  
**Install/Update Disk**, 20, 22  
Installing Wallboard Hardware, 24

## K

**KSU** screen, 31, 32

## L

Line Admin, 76, 80  
**Line Admin** screen, 73, 78  
Line Administration, 52, 67, 70, 81, 91, 159  
Line number, 74, 78  
Line Number, 76, 79  
Line number screen, 73, 74, 76, 77, 78, 79, 80  
Lines, 8  
Lines screen, 76, 77, 80, 81  
Log Out, 142  
**Logged in**, **139**  
Login, 8, 26, **138**, 146  
*Login DN (Directory Number)*, 90, 91  
**Login Errors**, **140**  
Login Feature Code, 28, 138, 142  
**Login Key**, 138, 142  
Login/Logout, 146  
**Login/Logout DN**, 146  
**Logout**, 146  
Longest Idle, 40  
LONGEST IDLE, 11

## M

M7310, 8  
M7310 or M7324 Station Set, 20, 22  
M7324, 8

## N

Name the Group, 38  
**New Password**, 97, 98, 122  
New Pswd screen, 96, 98, 122  
Night Command Routing Table, 11  
*Night Routing*, 43  
**NITE ANN**, 49  
NO ANSWER, 11, 49  
**None**, 84, 88  
**Non-Presentation Manager**, 20, 22  
**Norstar**, 2, 146

# Index

---

Norstar DN, 39, 48  
Norstar KSU, 20  
Norstar KSU string, 8  
**Norstar KSU string identifying the KSU currently in use**, 26  
Norstar Voice Mail, 8  
Norstar Voice Mail application, 43  
Norstar Voice Mail mailbox number, 47, 50  
Number of ACD Calls Abandoned, 8  
**Number of ACD Calls Abandoned by Callers**, 130  
**Number of ACD Calls Abandoned by Callers for the selected Date and Routing Time Period**, 126  
Number of ACD Calls Answered, 8  
**Number of ACD Calls Answered by Agents**, 129  
**Number of ACD Calls Answered by Agents for the selected Date and Routing Time Period**, 126  
**Number of ACD Calls Answered by Agents per Category Code**, 131  
Number of ACD Calls Disconnected, 8  
**Number of ACD Calls Disconnected by the Disconnect Night Routing Command**, 130  
**Number of ACD Calls Disconnected by the Disconnect Night Routing Command for the selected Date and Routing Time Period**, 126  
Number of ACD Calls Per Category Code, 8  
**Number of ACD Calls taken by Agents per Category Code for the selected Date and Routing Time Period**, 126

## O

Opts screen, 88  
OS/2, 20, 22  
Overflow Call, 141  
Overflow Calls threshold, 42  
Ovflow Calls screen, 42

## P

*Password Recovery*, 123  
**Phone Cord**, 24  
**Position Agent in Top Down order**, 56  
PRI, 70, 71, 73, 76, 78, 79, 80

## Q

Q#, 145

## R

Receiving Calls, 141  
Record an Announcement, 100  
**RECORD Key**, 100  
**Reset Administration Session (930), Routing Session (931), and Administration Maintenance Session (9\*7) Passwords**, 108  
Reset Administration Session Configurations, 118  
Reset All Passwords, 121  
Reset Config screen, 115, 116, 117, 118, 120, 121  
Reset Config: NO screen, 118, 120  
**Reset Configuration**, 8  
**Reset Configurations**, 108, 118, 120  
**Reset Passwords**, 8, 94  
Reset Passwords screen, 118, 121, 122  
RJ-11, 24



---

Rout FCode screen, 115, 116, 117  
*Routing change*, 128  
Routing Password screen, 105  
Routing screen, 105  
**Routing Session**, 8  
Routing Session Password, 8, 94, 105  
*Routing Time Period*, 106, 129  
*Routing: DAY screen*, 49  
Routing: NIGHT screen, 49  
**RS-232 Cable**, 24

## S

**SHOW Lines**, 70  
**SHOW list of Agents**, 56  
Softkeys, **138**  
**Specify Available/Unavailable DN**, 84, 90  
Specify Backup Station Set DN, 85  
Specify Day Routing Commands, 43  
**Specify ICLID Delay Time Period**, 84, 87  
**Specify Login/Logout DN**, 84, 89  
Specify Longest Idle or Top Down, 40  
Specify Overflow Calls, 42  
Specify Transfer (XFR) DN, 39  
Specify Wrap Duration, 40  
Station Sets, 20  
**Stats FCode screen**, 118, 120  
**System Admin screen**, 86  
System Administration, 52, 67, 81, 84, 91  
**System Administration, Passwords, and Feature Codes**, 160  
System Configurations, 85  
System Parameters, 8

## T

*Time format*, 129  
**Time In Queue**, 134  
Time screen, 128  
TMM:SS, 145  
Top Down, 40  
TOP DOWN, 11  
*Top Down Form*, 61, 63, 64  
Top Down list, 62  
Transfer DN, 39  
**Transfer DN (Extension)**, 39  
TRANSFER TO, 11  
**Transfer to DN (Extension)**, 48

## U

Unavailable, 8, 26, **138**  
Unavailable Feature Code, 28, **143**  
**Unavailable Key**, **143**  
Unavailable/Available, 143  
Update Config, 82, 92

# Index

---

Update Configuration, 52, 56, 67, 70, 81, 84, 91  
Update Configuration later, 52, 67, 82, 92, 119  
Update Configuration now, 67, 81, 91, 119  
Update Configurations, 52  
Update Configurations now, 52  
Update pending, 52, 67, 81, 91  
**Using Analog 2500 Sets**, 138, 146

## V

Verify Pswd screen, 97, 98  
Viewing Administration Statistics, 128  
Viewing Group Status, 135  
**Viewing/Editing an existing Agent**, 56, 65  
**Viewing/Editing an existing Line**, 70, 75, 79  
VMAIL XFER, 11, 43  
VMAIL XFER (Night), 11  
**VMAIL XFR**, 49  
VMAIL XFR screen, 47  
Voice Mail Application, 20

## W

*Wait Announcement*, 46  
WAIT ANNOUNCEMENT, 11, 43  
**Wallboard**, 84, 88  
**Wallboard Jack**, 24  
WallFormat screen, 88  
Wrap Duration, 40

## X

**XFR DN**, 43  
*XFR TO DN*, 47  
XFR TO DN screen, 48

## Z

zip tone, 60, 61